

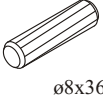

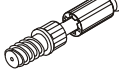







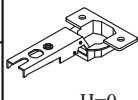
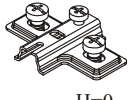

90 min

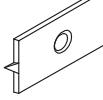
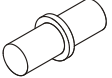
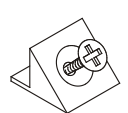
A1 X16  ø8x36	B4 X14 	B5 X14  ø15x12	P3 X2 	G5 X14 	D11 X6  USØ3,5x25
E1 X6  H=0	E2 X6  H=0	ST2 X6 	D9 X8  USØ3x20	G16 X8 	G7 X16 
S1 X16 	D10 X14  USØ3,5x13	G2 X1 	UP13 X18  UPØ3x16	T1 X1 	G20 X4 
KR1 X1 	L1 X1 	P2 X18 			

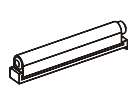
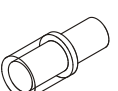
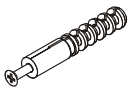
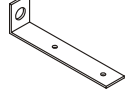

1

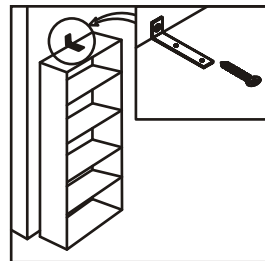
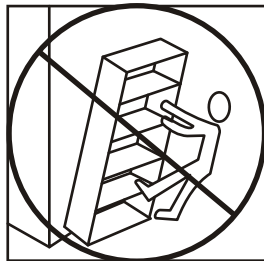
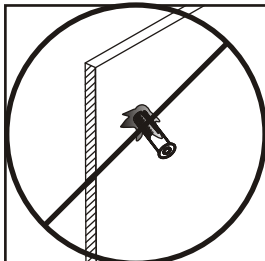
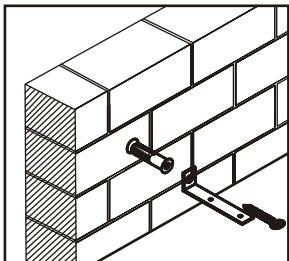
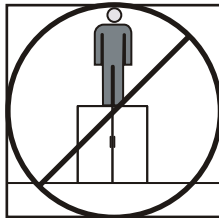
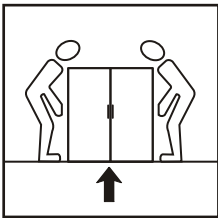
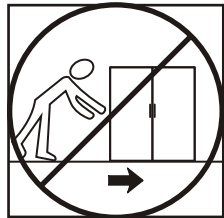
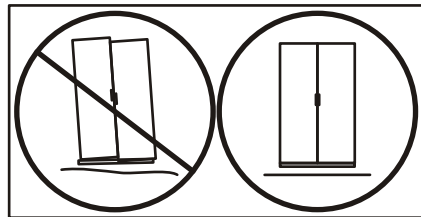
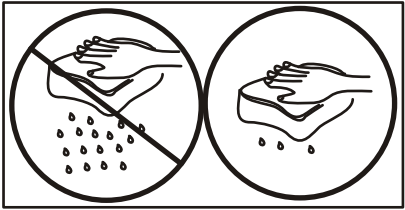
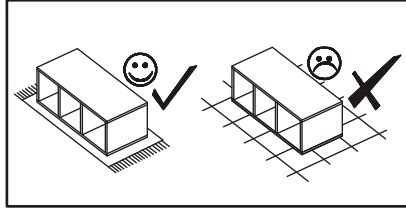
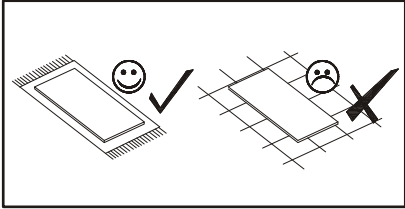
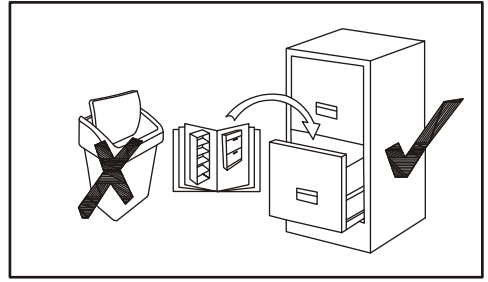
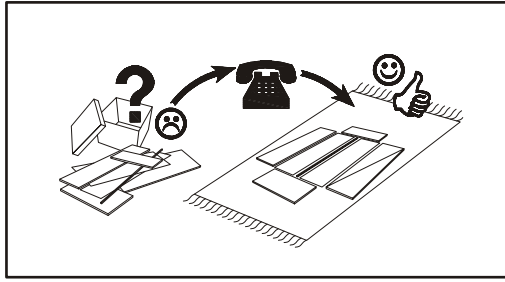
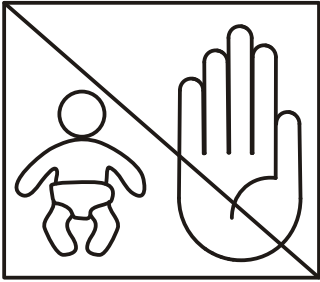
180°

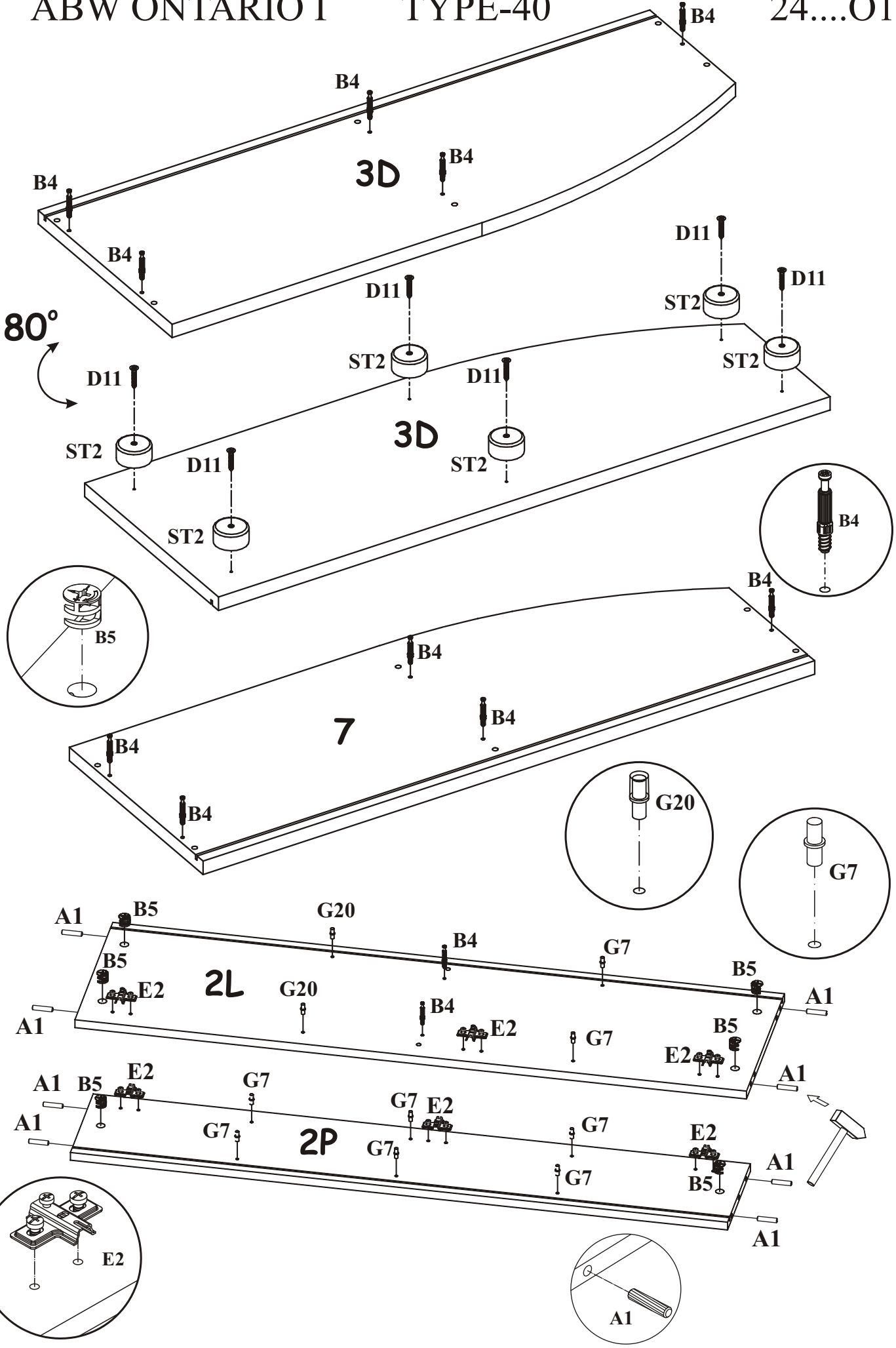

2

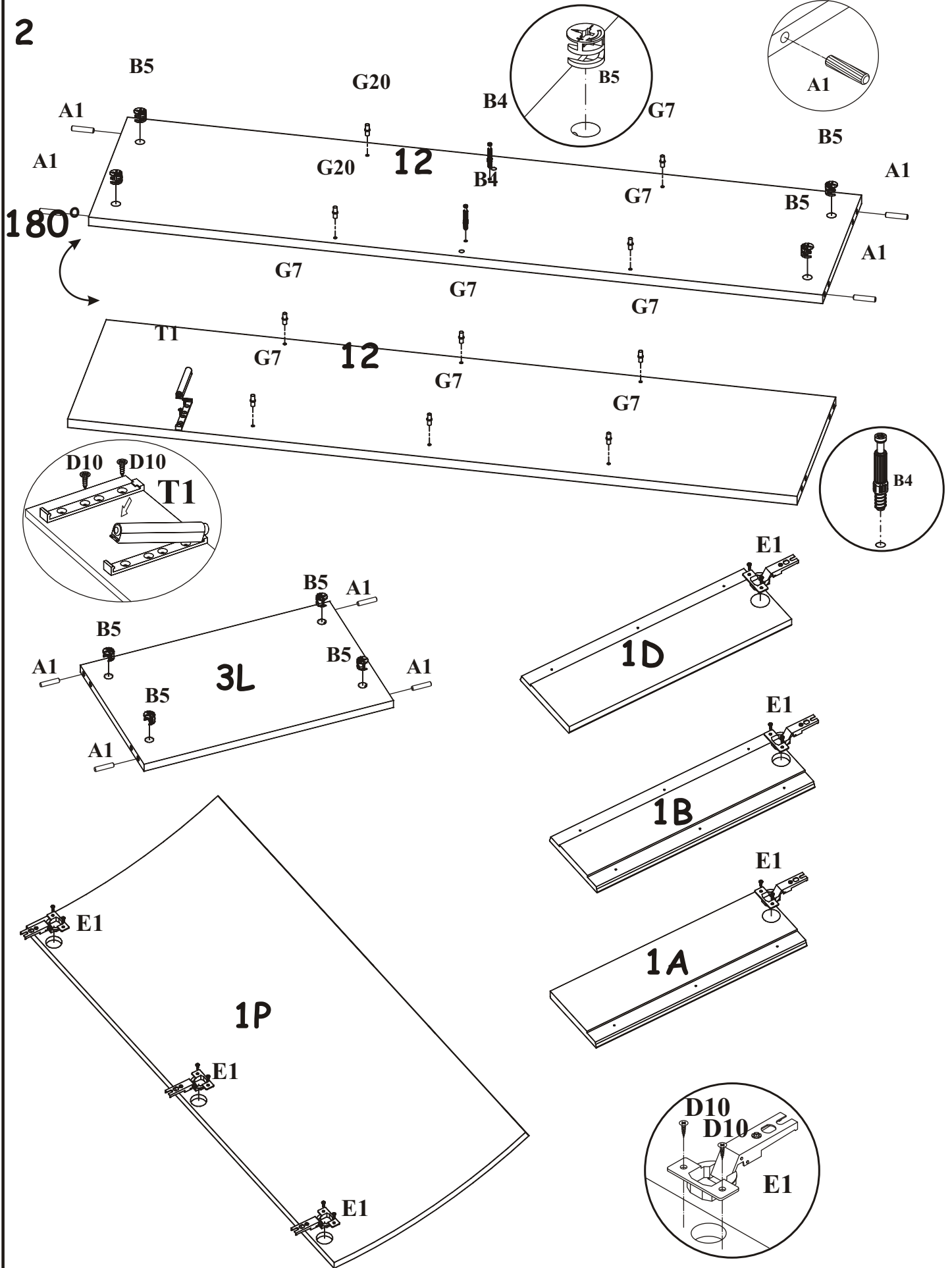

3

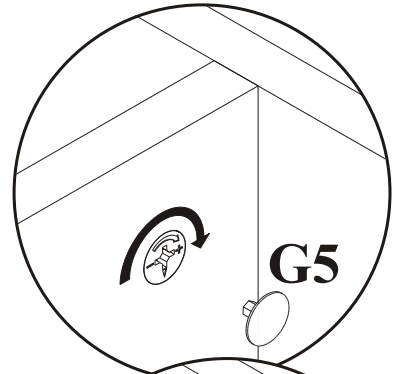
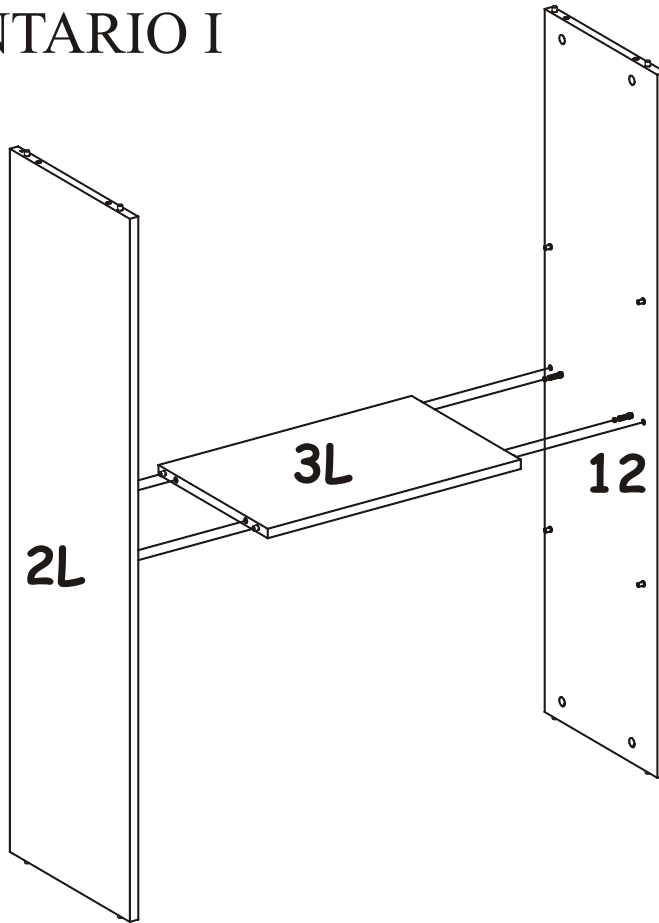

4

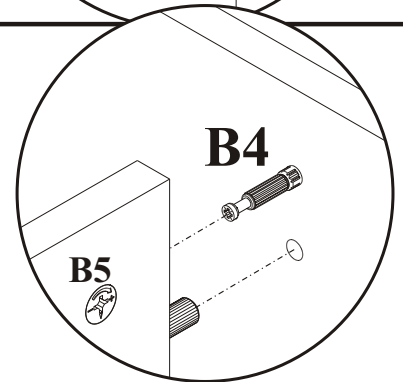
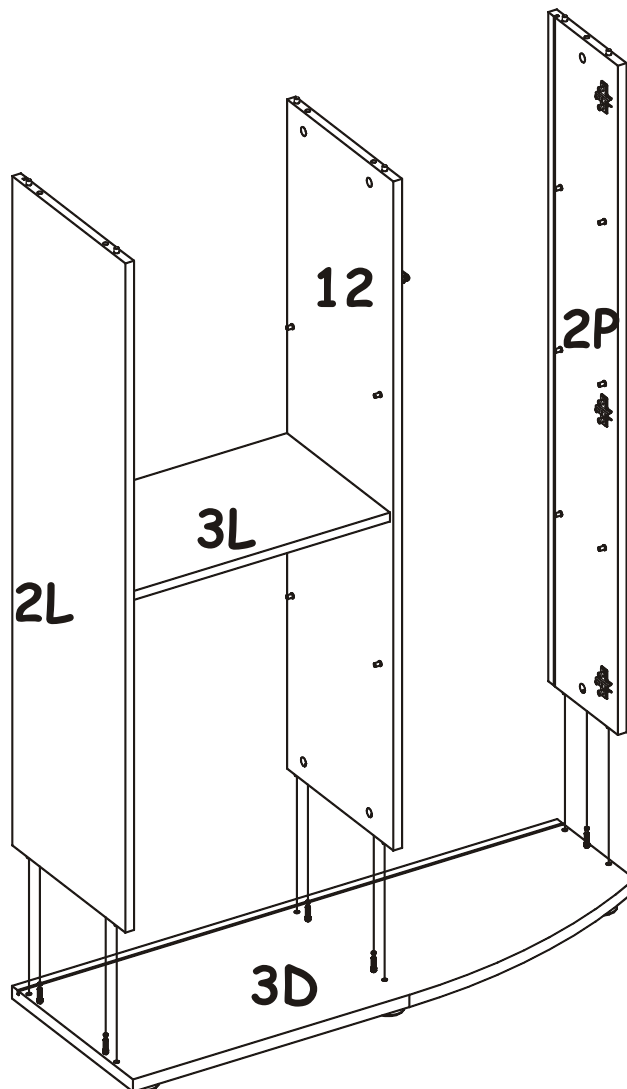

5

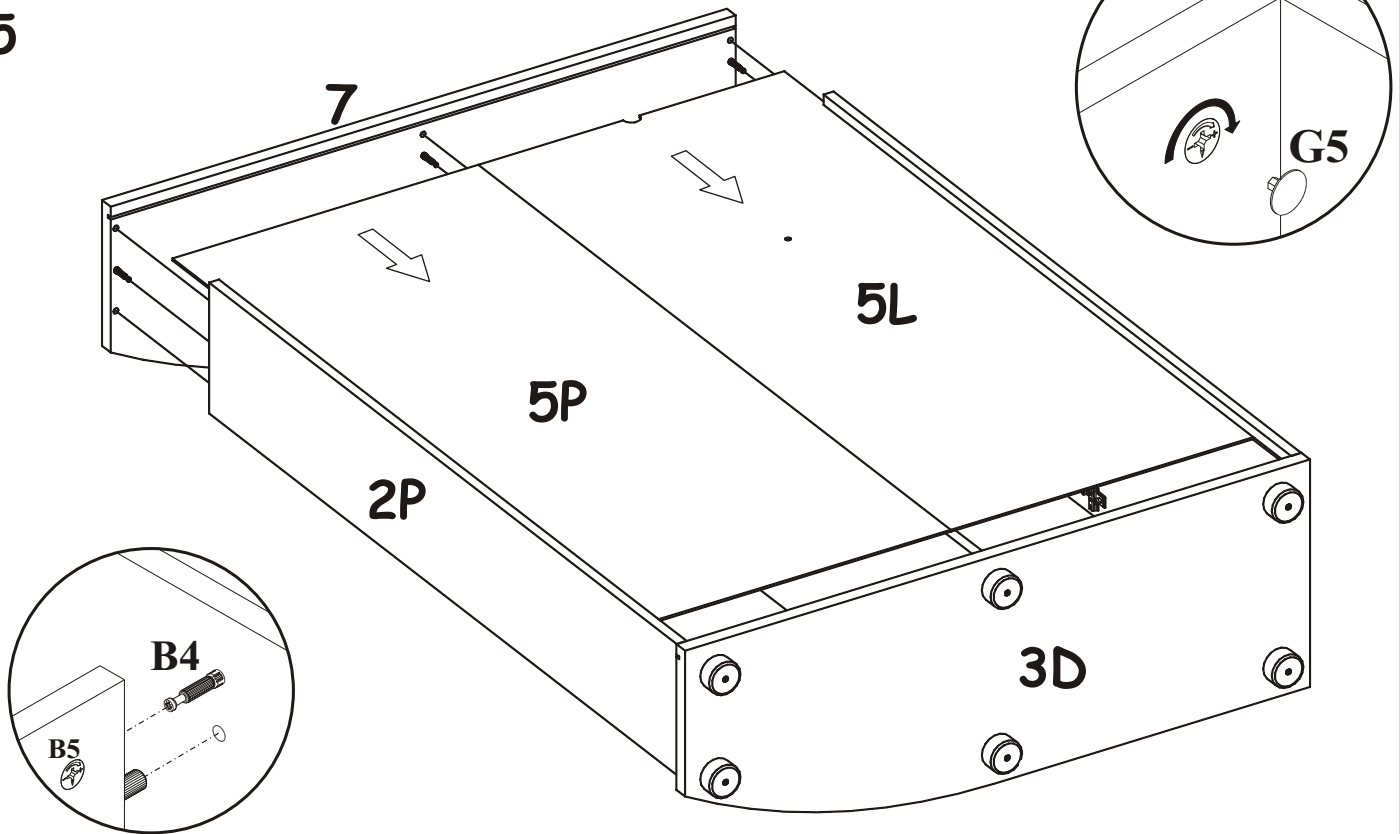

6

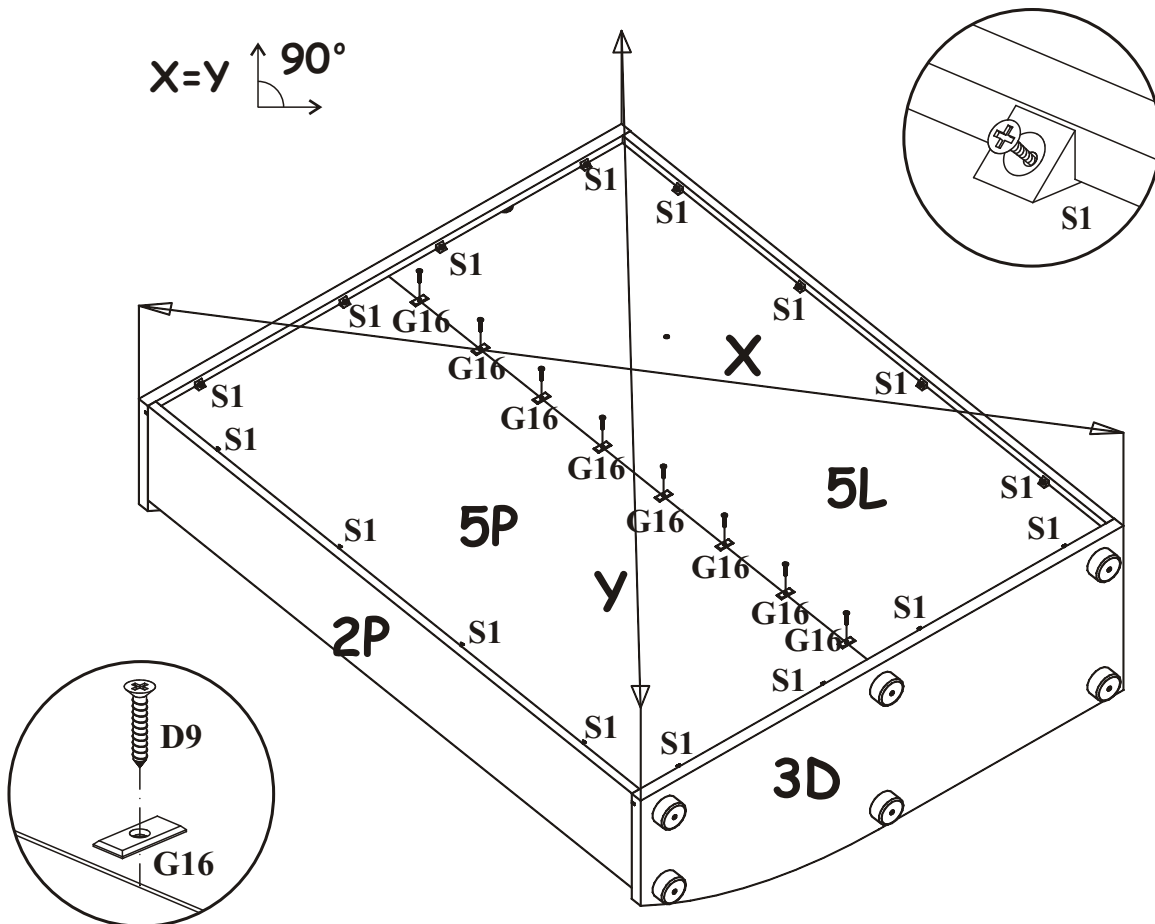

7

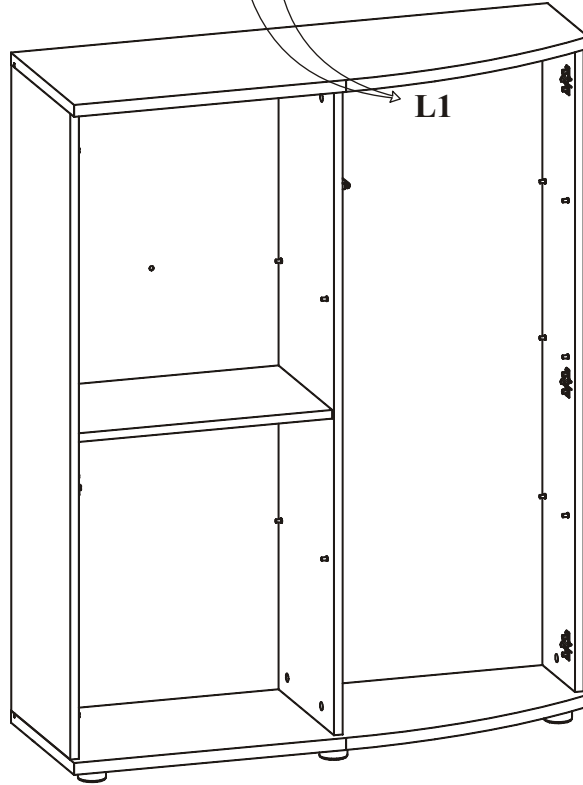
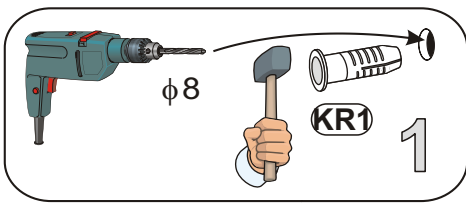
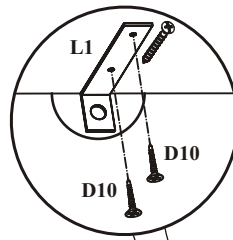
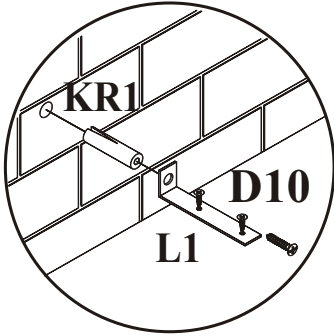

8

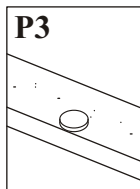
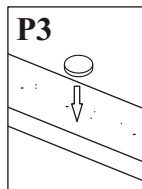
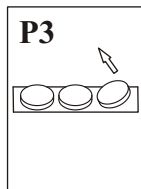
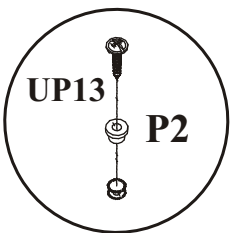
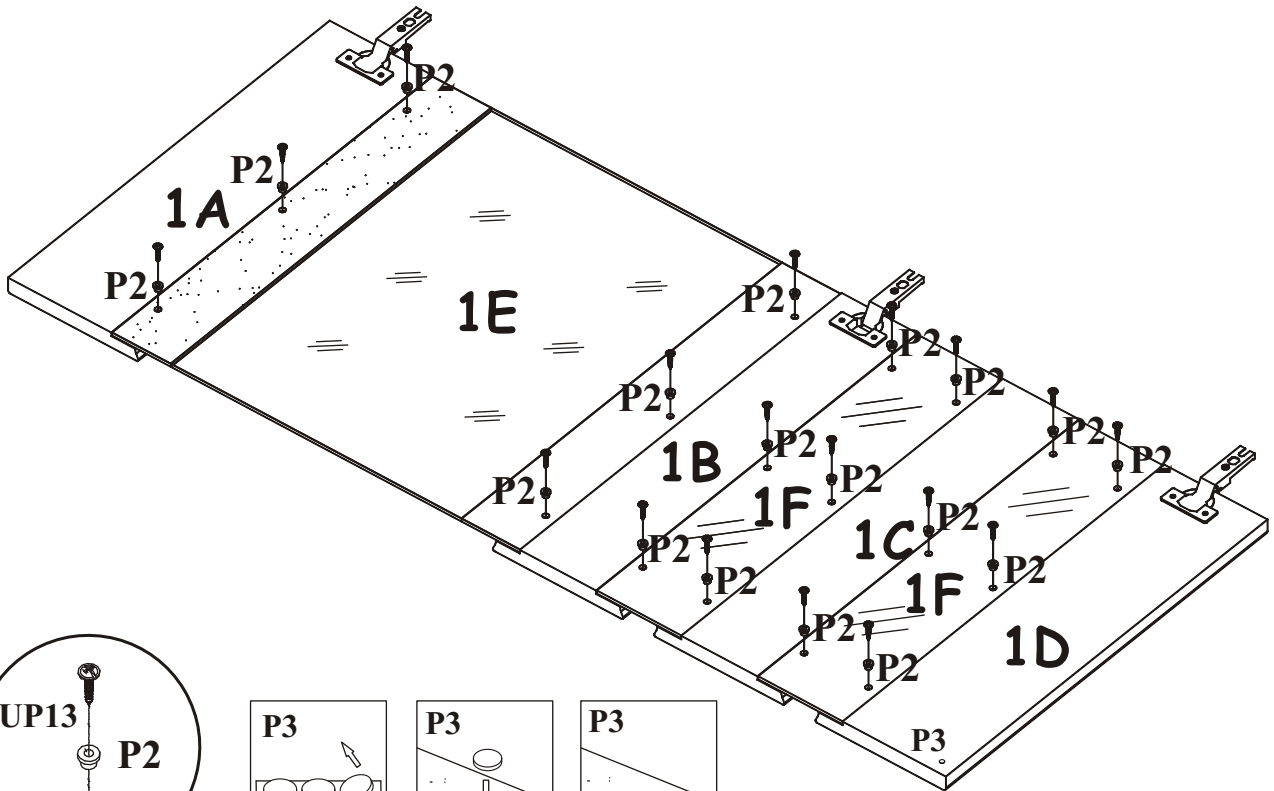

9

