

# MODEL: KRONE

## NR. 30

KRONE I

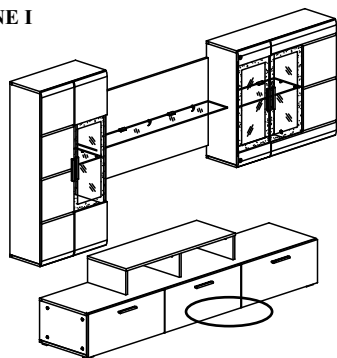

KRONE II

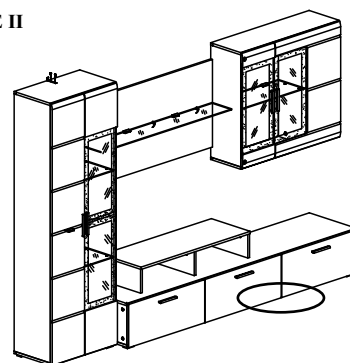

KRONE III

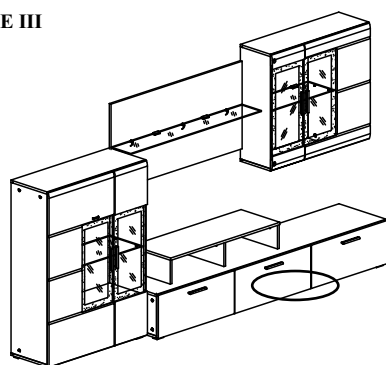

KRONE IV

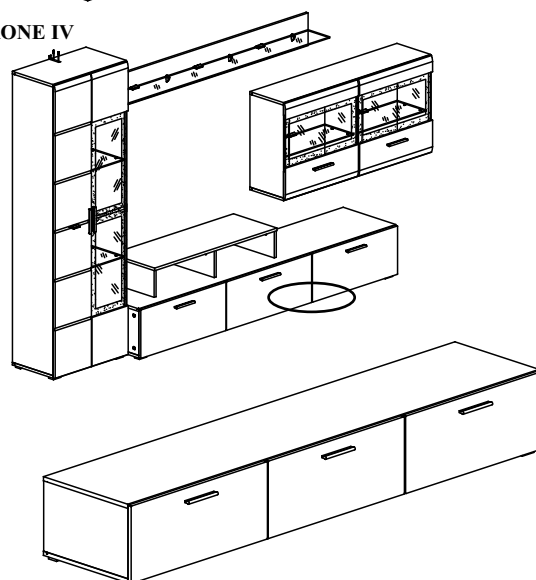

**(D)** Montageanleitung  
**(NL)** Handleiding voor de montage  
**(TR)** Montaj talimatı

**(GB)** Assembly instructions  
**(PL)** Instrukcja montażu  
**(FR)** Instructions d'installation

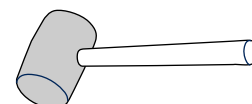
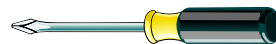
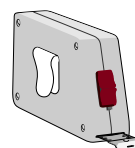
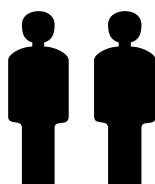

**Sicherheitshinweise • Safety instructions • Veiligheidsinstructies •  
Wskazówki bezpieczeństwa • Güvenlik uyarıları • Consignes de sécurité**

FR	<ol style="list-style-type: none"> <li>1. Nettoyez à sec ou à l'aide d'un chiffon humide. N'utilisez pas de poudre à récurer ou tout autre détergent agressif.</li> <li>2. Produit n'est pas adapté pour un usage extérieur.</li> <li>3. Il ne faut pas dépasser la charge maximale mentionnée dans la notice de montage : le meuble risque d'être abimé ou endommagé.</li> <li>4. Protégez le meuble contre l'eau (p.ex. pendant l'arrosage des plantes et le nettoyage) : l'humidité peut pénétrer dans le meuble et l'endommager.</li> <li>5. Mettez tous les emballages hors de la portée des enfants! Danger d'étouffement ou de blessure.</li> </ol>
NL	<ol style="list-style-type: none"> <li>1. Reinig allen met een stofdoek off een lichtjes vochtige doek. Gebruik geen schurende poetsmiddelen.</li> <li>2. Het product is niet geschikt voor het gebruik in open lucht.</li> <li>3. Overschrijd de aangegeven maximale belastingen niet. Anders kan het meubelstuk worden beschadigd of vernield.</li> <li>4. Bescherm uw meubelen doorgaans tegen water (bijv. bij het dweilen of als u de bloemen water geeft). De vochtigheid kan in het meubelstuk dringen en het beschadigen.</li> <li>5. Het artikel is geen speelgoed voor kinderen! Zorg ervoor dat kinderen ook niet met de verpakking spelen. Ze kunnen stikken door de folie of zich verwonden aan de verpakking.</li> </ol>
PL	<ol style="list-style-type: none"> <li>1. Czyszczenie należy wykonać wyłącznie za pomocą ściereczki lub lekko nawilżonego ręcznika. Nie stosować środków czyszczących do szorowania.</li> <li>2. Produkt nie jest przystosowany do zastosowań na wolnym powietrzu.</li> <li>3. Nie wolno przekraczać podanych maksymalnych wartości obciążenia. W innym przypadku można mebel uszkodzić lub zniszczyć.</li> <li>4. Mebel należy chronić przed wodą (np. podczas czyszczenia lub podlewania kwiatów). Wilgoć może wnikać w mebel i uszkodzić go.</li> <li>5. Produkt nie służy do zabawy! Dzieci nie powinny bawić się opakowaniem produktu, gdyż mogą się udusić folią lub skaleczyć opakowaniem.</li> </ol>
GB	<ol style="list-style-type: none"> <li>1. Please only clean with a duster or a damp cloth. Do not use any abrasive cleaners.</li> <li>2. The product is not suitable for outdoor use.</li> <li>3. Do not exceed the maximum loads specified. Otherwise, the furniture may sustain damage or be irreparably damaged.</li> <li>4. In general, keep water away from your furniture (e. g. when mopping or watering plants). The moisture may penetrate the furniture and damage it.</li> <li>5. This product is not a toy! Do not allow children to play with the packaging. They could suffocate in the foil or injure themselves on the packaging.</li> </ol>
TR	<ol style="list-style-type: none"> <li>1. Lütfen sadece bir toz beziyle veya hafif nemli yumuşak bir bezle siliniz. Aşındırıcı temizlik malzemeleri kullanmayınız.</li> <li>2. Bu ürün açık havada kullanılmaya uygun değildir.</li> <li>3. Belirtilen azami yük değerini aşmayınız, aksi takdirde mobilya parçası zarar görebilir veya kullanılamaz hale gelebilir.</li> <li>4. Genelde mobilyalarınızı sudan koruyunuz (örneğin, yerleri paspaslarken veya çiçekleri sularken). Nem, mobilya parçasına nüfuz edebilir ve zarar verebilir.</li> <li>5. Bu ürün bir çocuk oyuncağı değildir! Çocukların ürün ambalajlarıyla oynamalarına asla müsaade etmeyiniz. Çocuklar, folyo nedeniyle boğulabilir veya ambalaj nedeniyle yaralanabilirler.</li> </ol>
D	<ol style="list-style-type: none"> <li>1. Bitte nur einem Staubtuch oder leicht feuchtem Lappen reinigen. Keine scheuernden Putzmittel verwenden.</li> <li>2. Das Produkt ist nicht für die Anwendung im Freien geeignet.</li> <li>3. Überschreiten Sie die angegebenen Maximalbelastungen nicht. Andernfalls kann das Möbelstück beschädigt oder zerstört werden.</li> <li>4. Schützen Sie Ihre Möbel generell vor Wasser (z.B. beim Wischen oder Blumen gießen). Die Feuchtigkeit kann in das Möbelstück eindringen und es beschädigen.</li> <li>5. Der Artikel ist kein Kinderspielzeug! Lassen Sie Kinder auch nicht mit der Verpackung spielen. Sie könnten an der Folie ersticken oder sich an der Umverpackung verletzen.</li> </ol>

## Service \* Dienstverlenig \* Serwis \* Servis \* Сервисная служба

Name * Naam* Nazwa* Isim *Название
KRONE
Nr* No* Номер
23...
Typ* Type* Tip* Тип
30

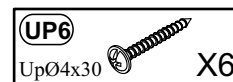
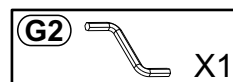
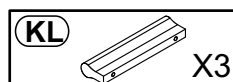
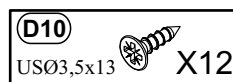
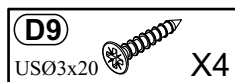
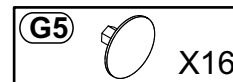
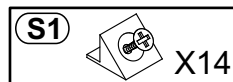
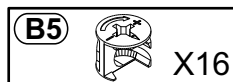
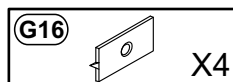
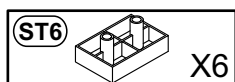
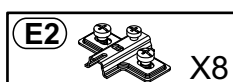
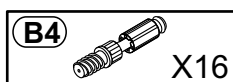
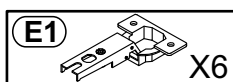
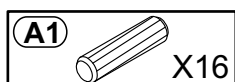
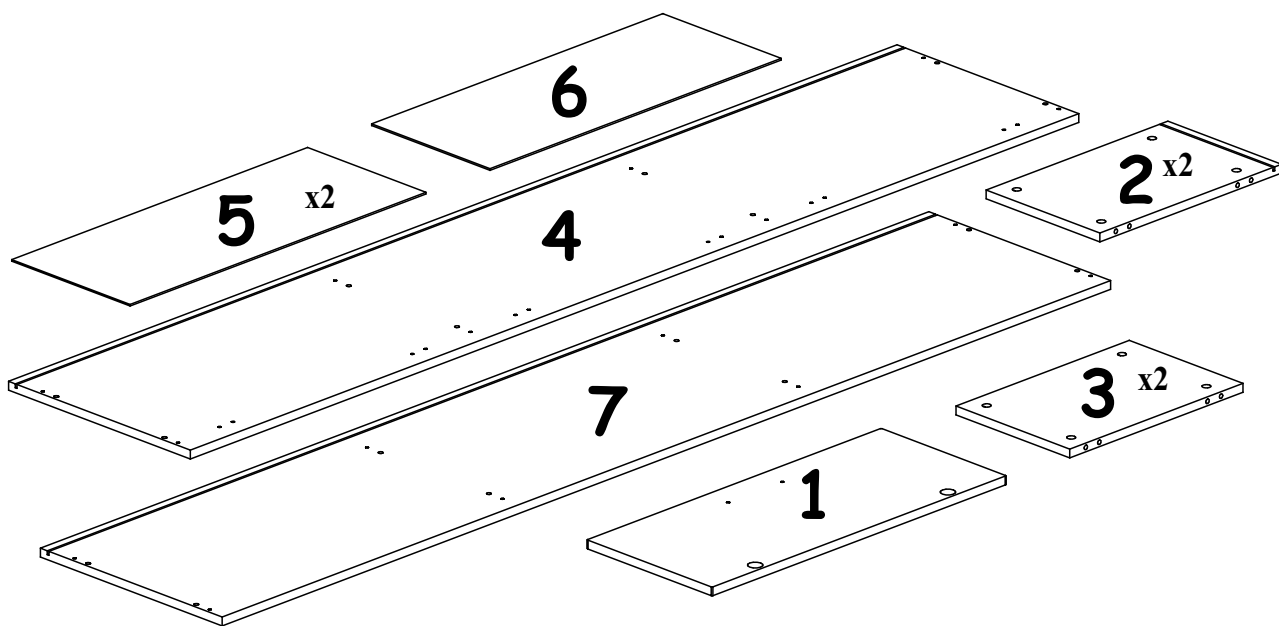
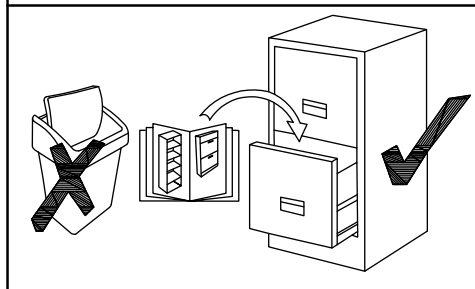
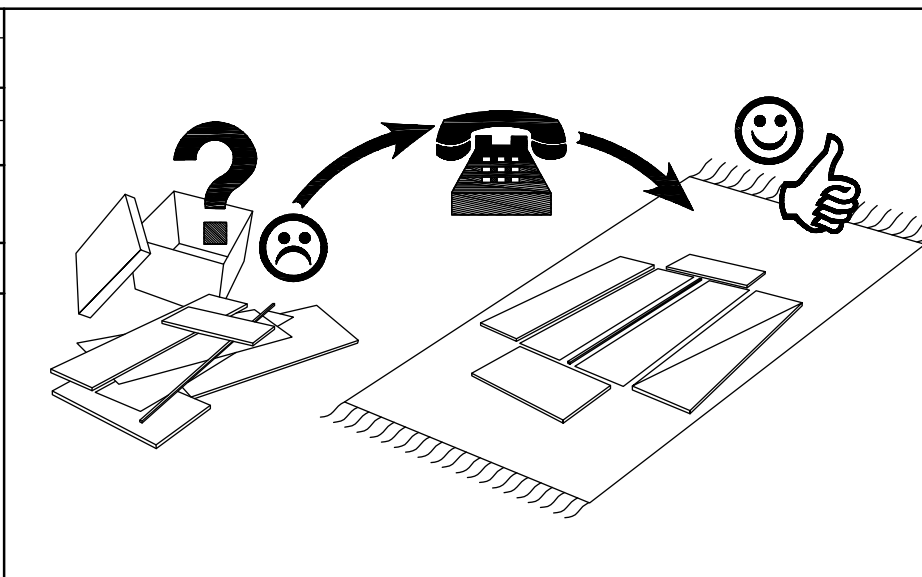

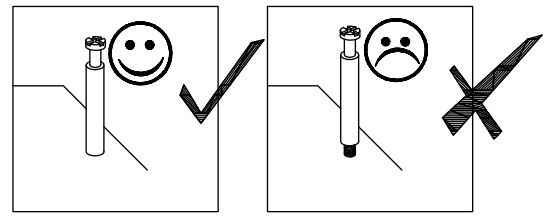
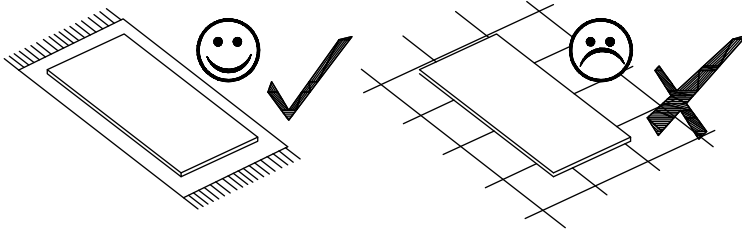

**(A1)** X16

**(B5)** X16

**x2**

**2**

**3**

**x2**

**(B4)** X8

**7**

**(ST6)** X6

**(B4)** X8

**(E2)** X6

**4**

**180°**

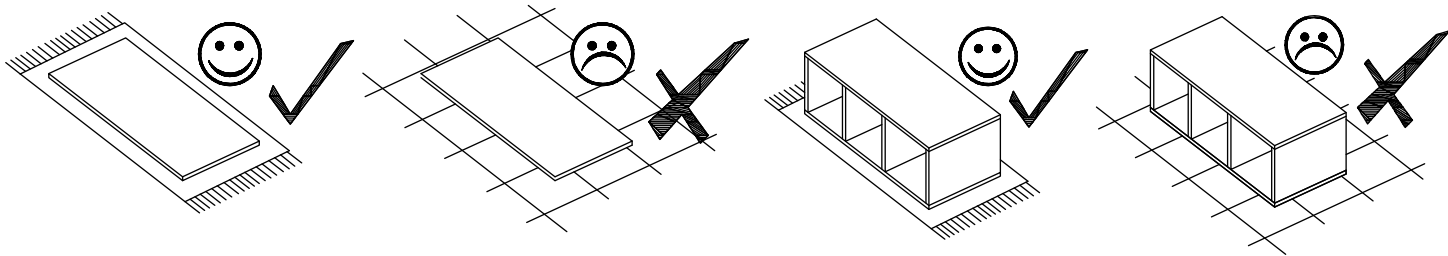

<b>E1</b>  X6	<b>D10</b> USØ3,5x13  X12	<b>x3</b>		
<b>KL</b>  X3	<b>UP6</b> UpØ4x30  X6			

<b>G5</b>  X16		
<div style="display: flex; justify-content: space-around;"> <div style="text-align: center;"> </div> <div style="text-align: center;"> </div> <div style="text-align: center;"> </div> </div>		

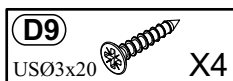
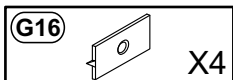
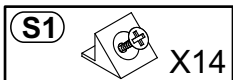
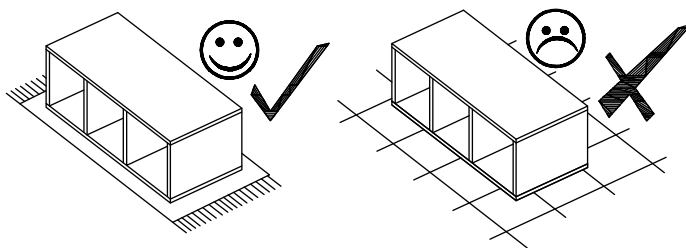

$X=Y$   $90^\circ$

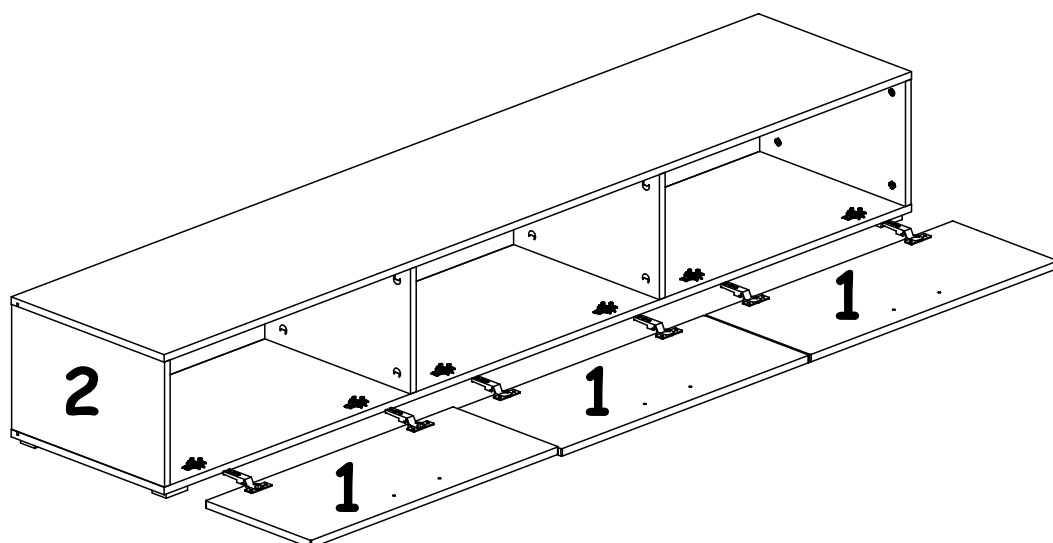
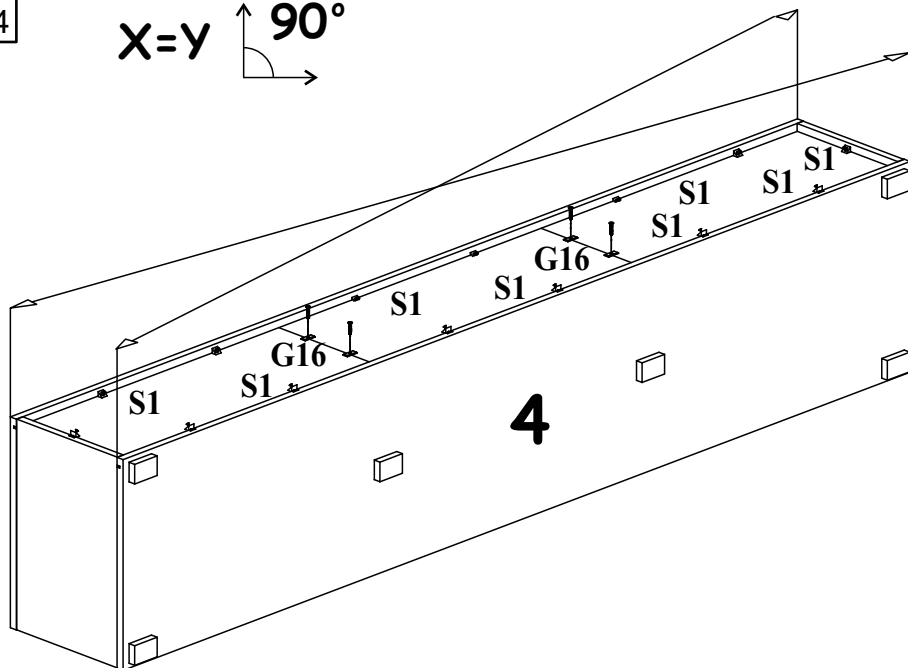
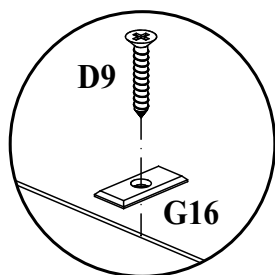
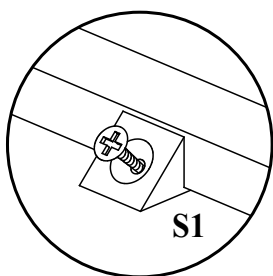

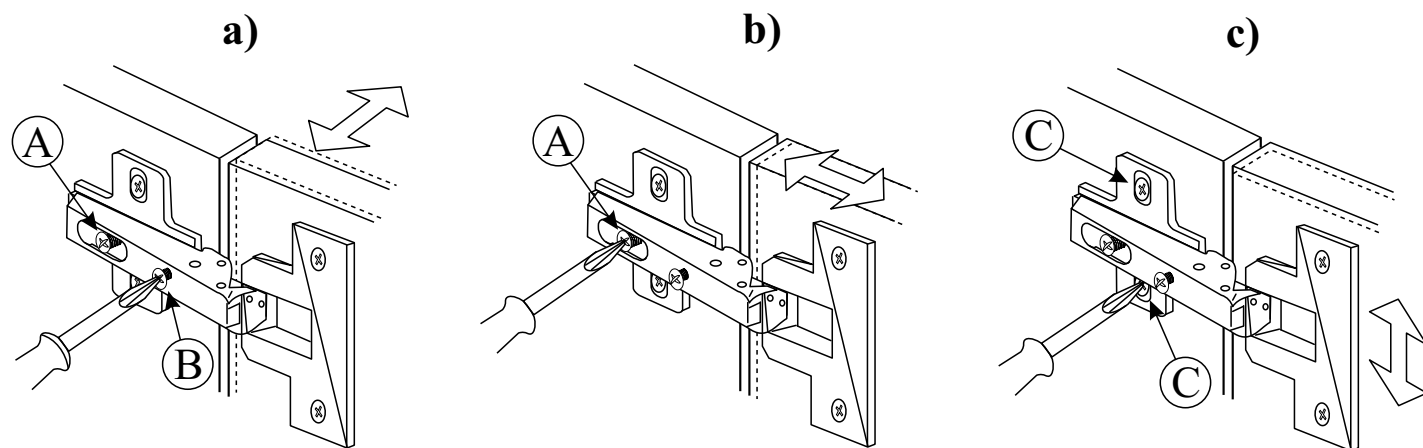

**Verstellmöglichkeiten**

- a) Fugenverstellung:  
Befestigungsschraube "A" lockern, gewünschte Fuge mit Schraube "B" einstellen, Schraube "A" anziehen.
- b) Tiefenverstellung:  
Befestigungsschraube "A" lockern, Bandarm nach vorne oder rückwärts verschieben, Schraube "A" anziehen, Schraube "B" mit einer 1/4 Drehung nach rechts arretieren.
- c) Höhenverstellung:  
Befestigungsschraube "C" lockern, Höhe einstellen, Schraube "C" anziehen.

**Instructions for hinge adjustment**

- a) Side adjustment:  
Loosen fixing screw "A", adjust gap with screw "B" and retighten screw "A".
- b) Depth adjustment:  
Loosen fixing screw "A", push hinge arm forwards or backwards, retighten screw "A", fix screw "B" with a 1/4-turn in clock-wise direction.
- c) Height adjustment:  
Loosen screw "C", adjust height, retighten screw "C".

**Les possibilités de positionnement**

- a) Positionnement de la rainure:  
Desserrer la vis de fixation "A", positionner avec la vis "B" la rainure (joint) souhaitée et resserrer la vis "A".
- b) Positionnement de la profondeur:  
Desserrer la vis de fixation "A" (1 tour), régler la profondeur et resserrer la vis "A".
- c) Positionnement de la hauteur:  
Desserrer la vis de fixation "C" (1 tour), positionner la hauteur et resserrer la vis "C".

**Możliwości regulacji**

- a) Regulacja szczeliny:  
Poluzować wkręt "A", wkrętem "B" ustawić odpowiednią szczelinę, dokręcić wkręt "A".
- b) Regulacja głębokości:  
Poluzować wkręt "A" (1 obrót), ustawić głębokość, dokręcić wkręt "A".
- c) Regulacja wysokości:  
Poluzować wkręt "C" (1 obrót), dokonać regulacji wysokości położenia drzwi, wkręt "C" dokręcić.

Max. zulässige Belastungen von Einlegeböden in kg:

Maksymalne obciążenie półek w kg:

Stärke/Gr.	Spanplatte/Płyta			Glas/Szkło
Länge/Dł. mm	15	18	22	6
0<400				10
401<600	40	40	40	
601<800	24			6
801<1000	15	30		