

A	B	C	D
1	S406-4007	293	60
2	S416-0004	1746	496
3	S416-1004	1706	349
4	S416-1005	1706	349
5	S416-1006	1706	349
6	S416-2003	1200	350
7	S416-2004	1200	350
8	S416-3005	434	331
9	S416-3006	713	331
10	S416-3011	433	331
11	S416-4001	1180	60
12	S416-4003	1706	434

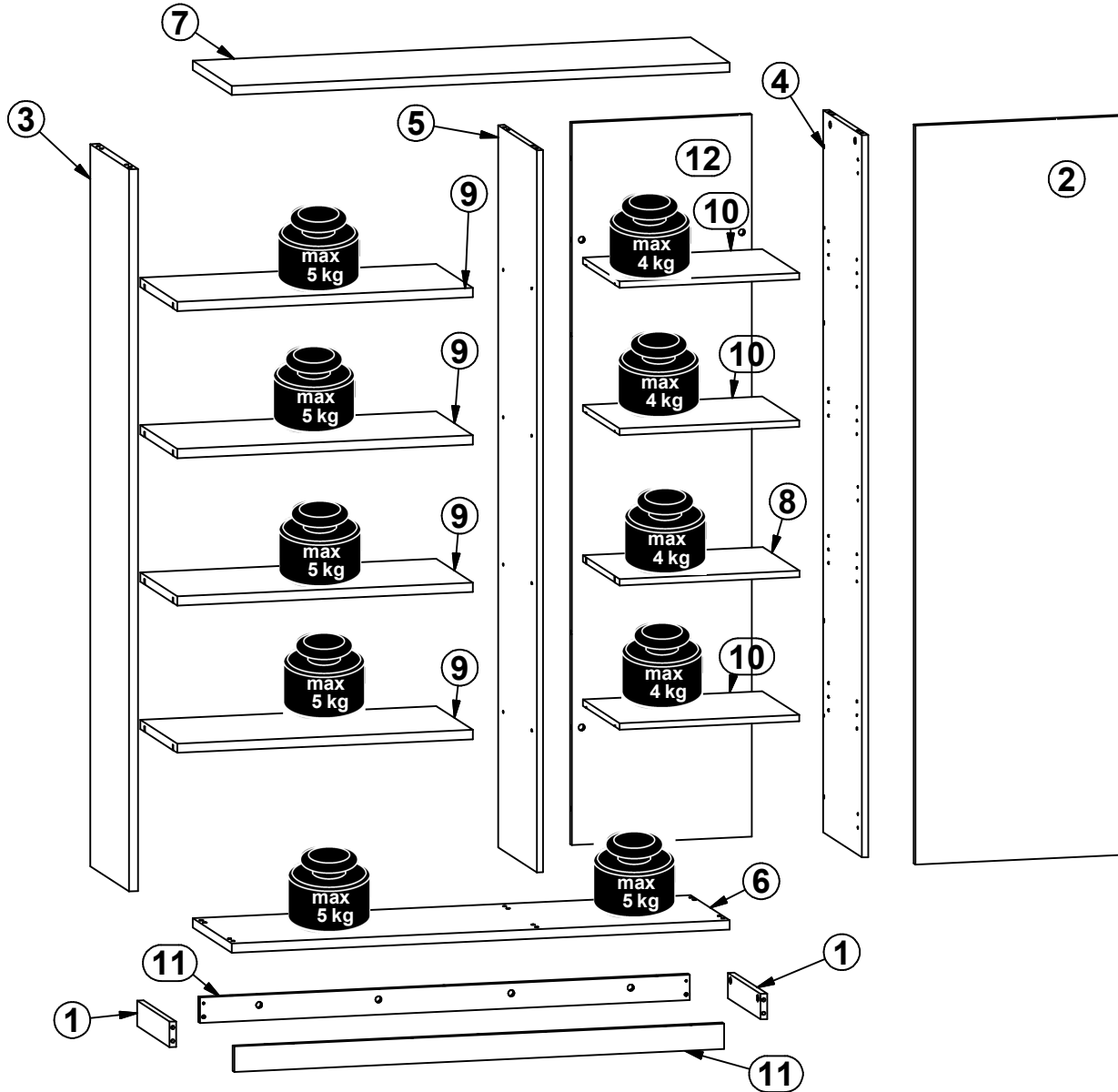

1x a133	3x a158	3x b43	12x d1 ∅5x17 mm	6x e2 ∅6.3x13 mm	6x e8 ∅7x60 mm	30x f1 ∅8x30 mm	6x k1	6x p51 ∅3.5x15 mm
22x r1 ∅15x12 mm #16	20x r37 6,7/7,8	22x r42 20/11	20x r50	10x s68 ∅ 20mm	1x z1 4 mm	1x n26	1x p38 ∅3.5x16 mm	

1 

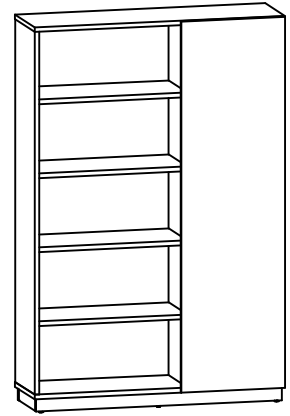
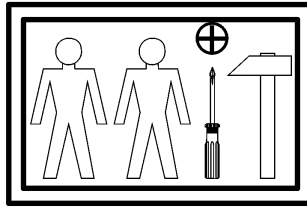
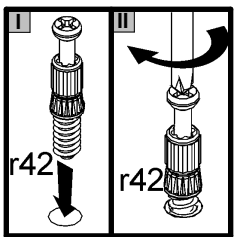
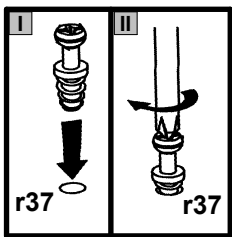
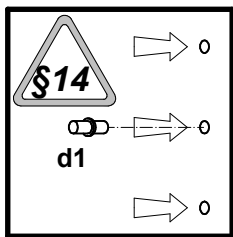
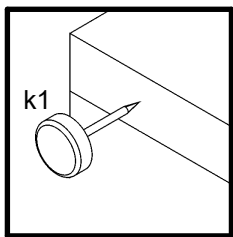
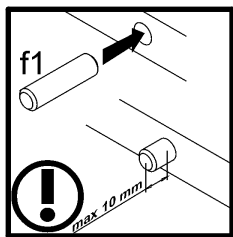
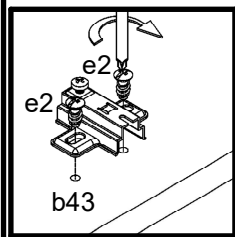
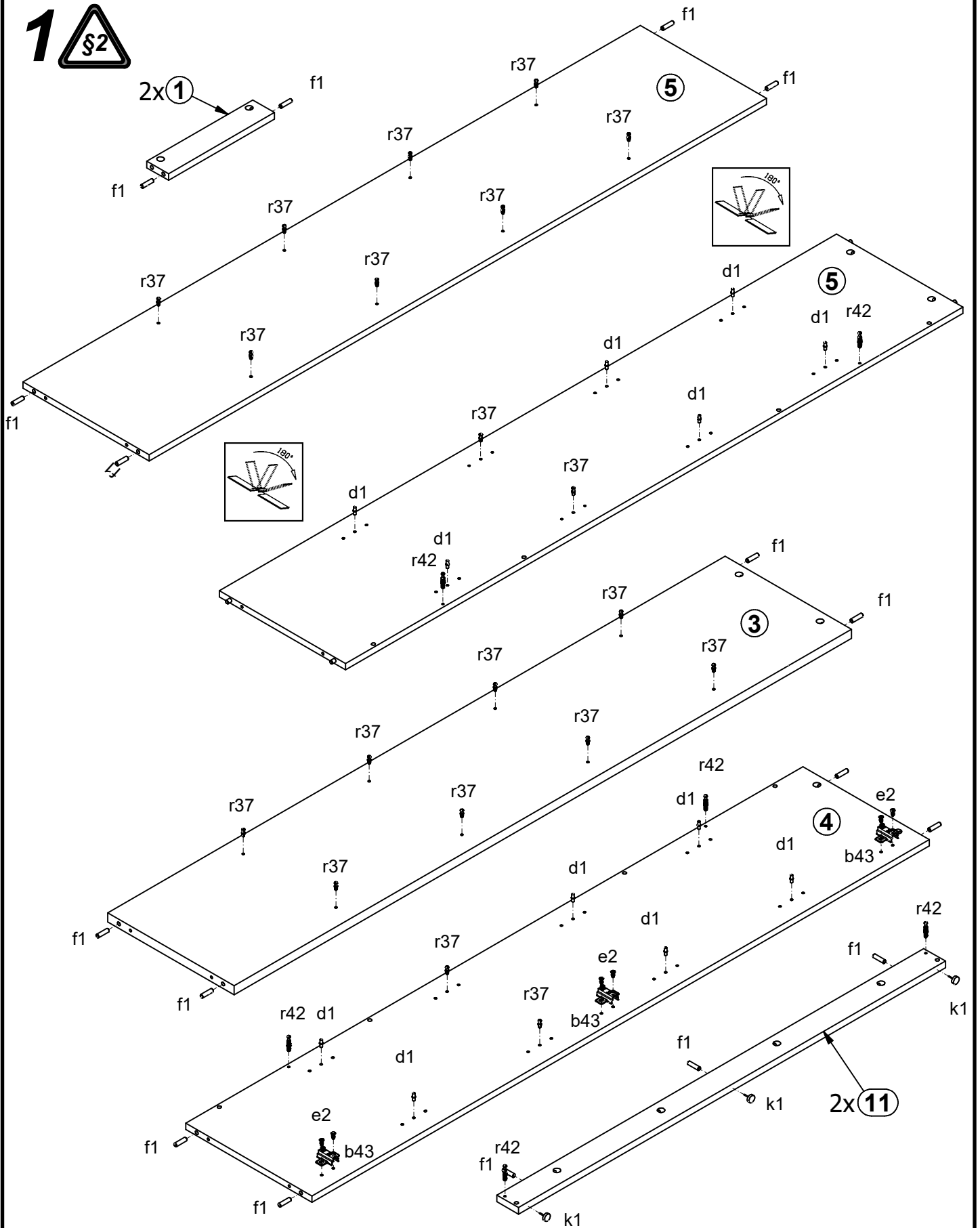

2

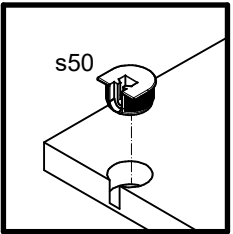
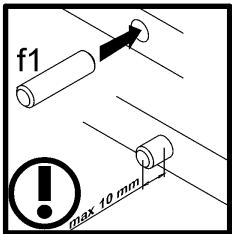
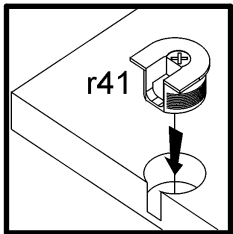
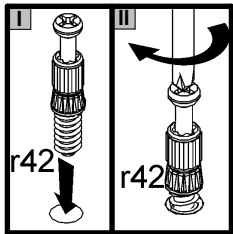
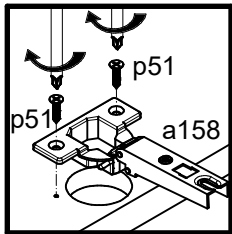
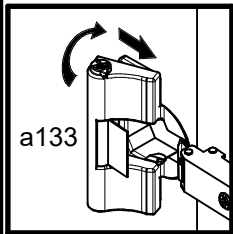
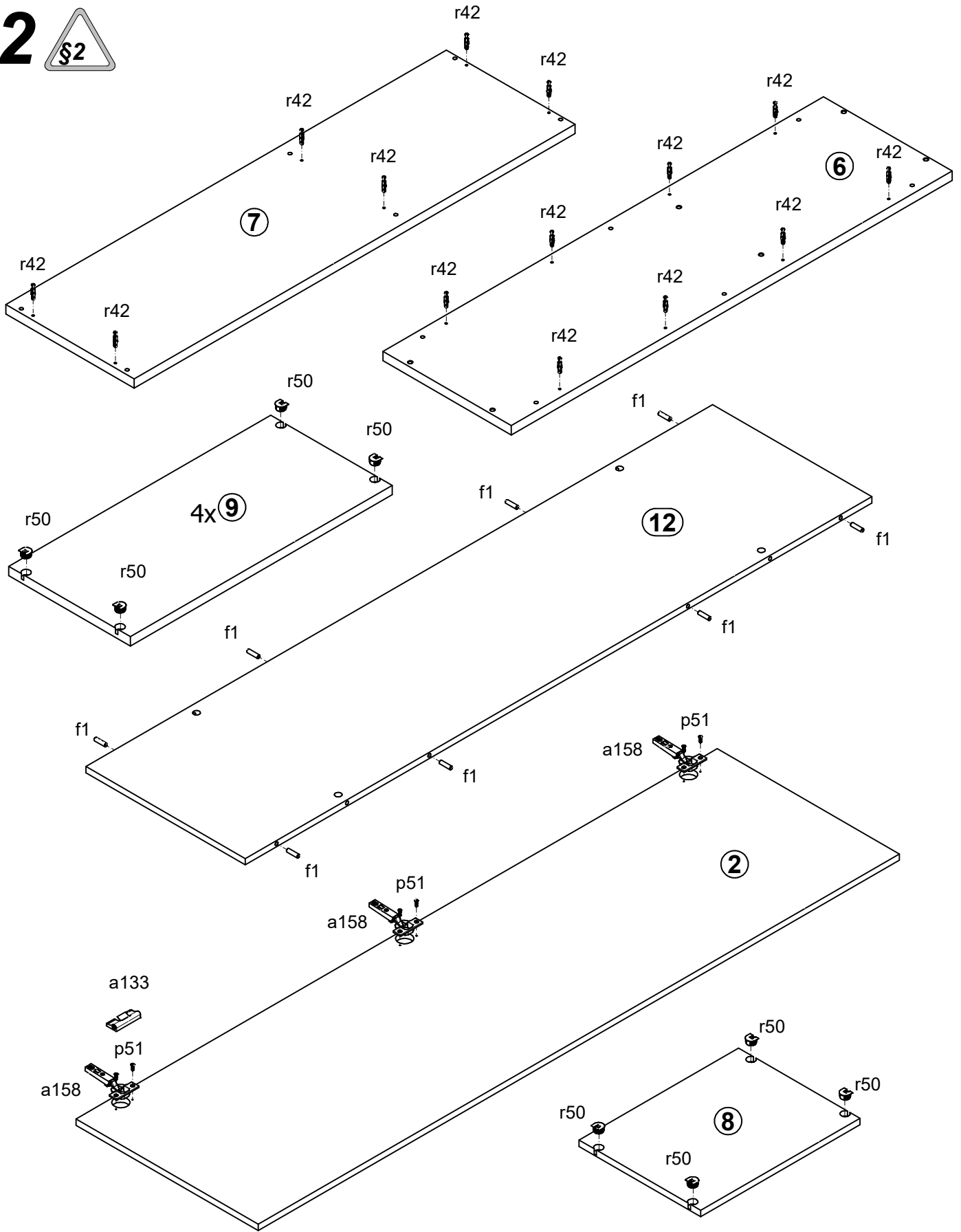

3

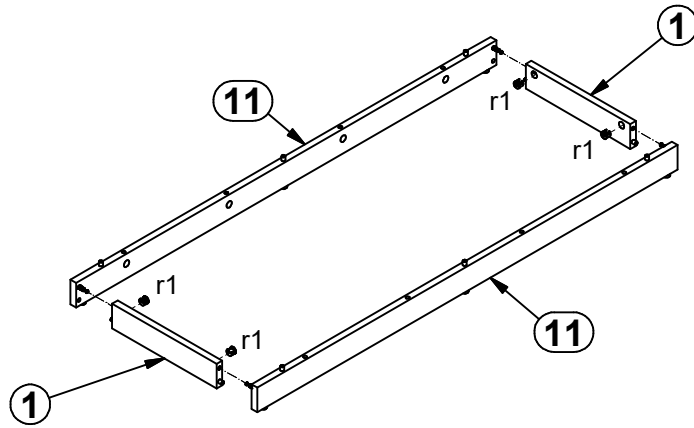

4

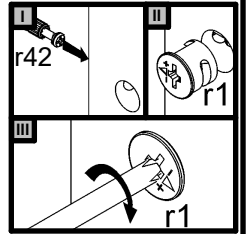
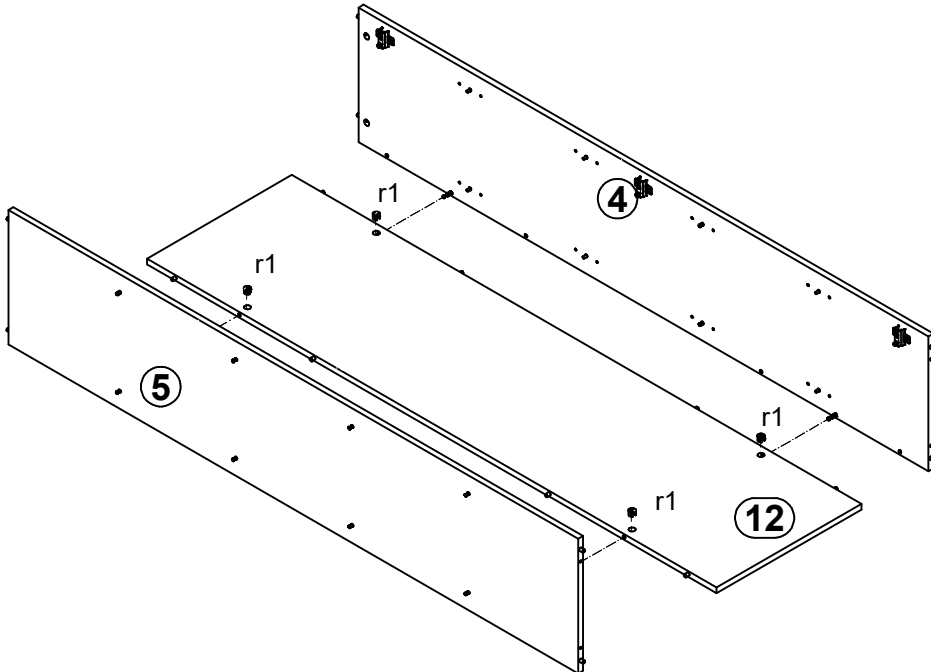

5

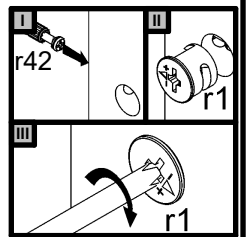
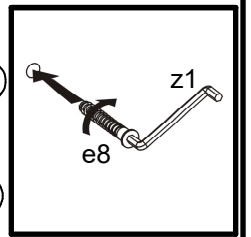
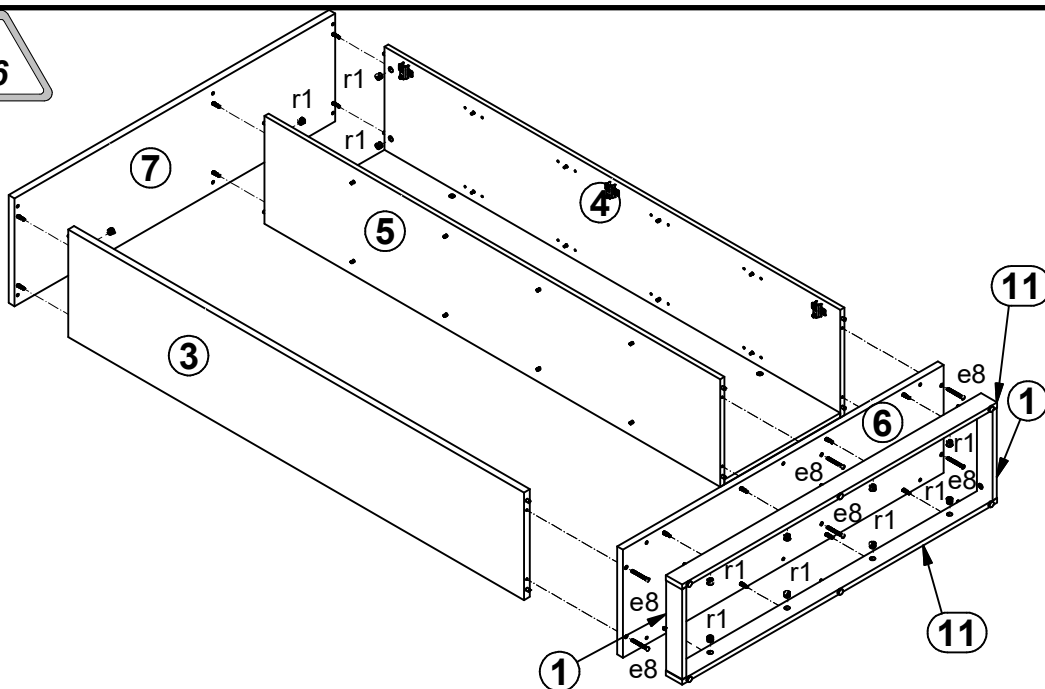

6

