

A	B	C	D
1	S406-4007	293	60
2	S416-0005	1056	496
3	S416-1007	1016	349
4	S416-1008	1016	349
5	S416-1009	1016	349
6	S416-2003	1200	350
7	S416-2004	1200	350
8	S416-3006	713	331
9	S416-3011	433	331
10	S416-4001	1180	60
11	S416-4004	1016	434

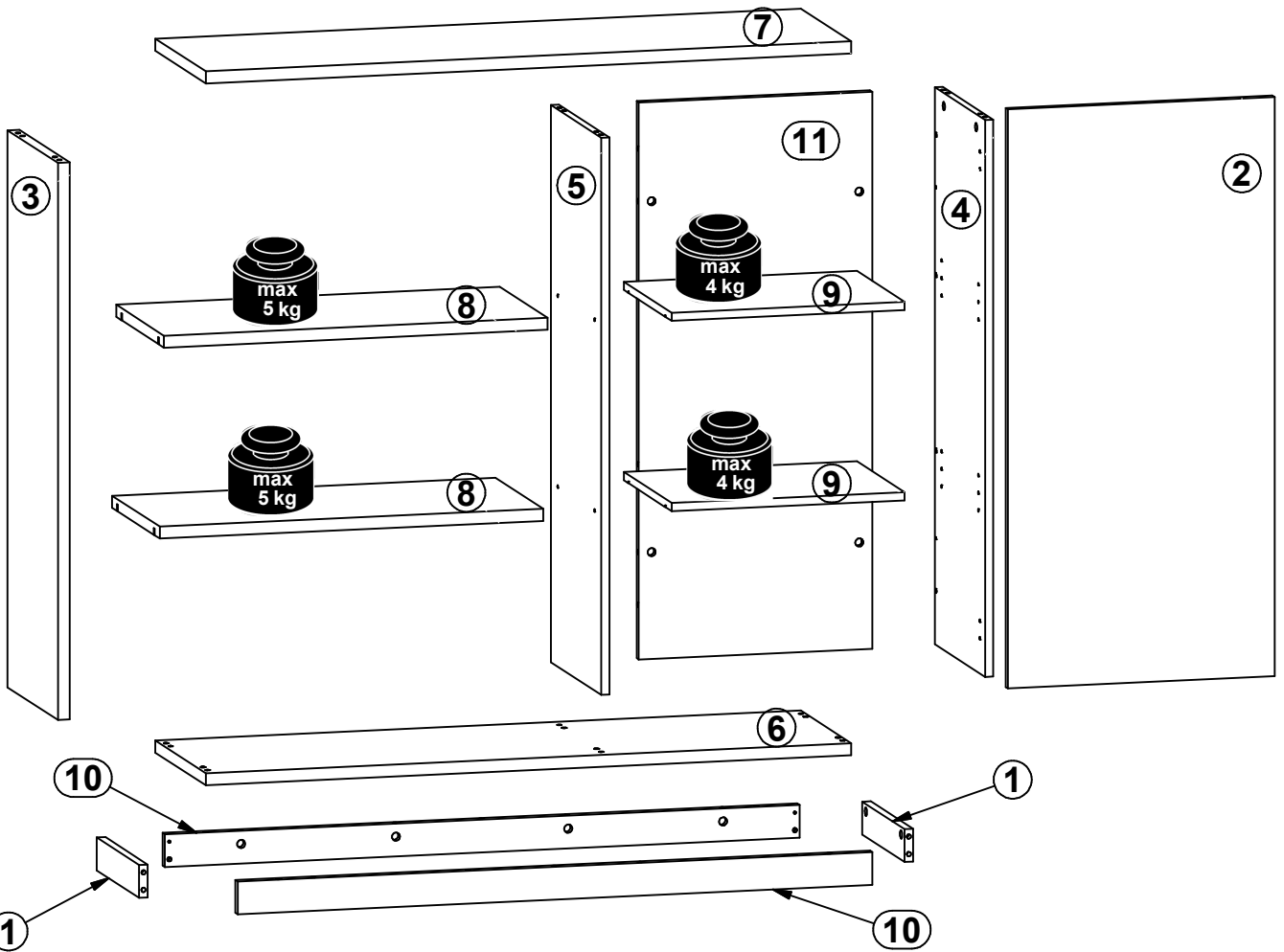

1x a133	2x a158	2x b43	8x d1 Ø5x17 mm	4x e2 Ø6.3x13 mm	6x e8 Ø7x60 mm	30x f1 Ø8x30 mm	6x k1	4x p51 Ø3.5x15 mm
22x r1 Ø15x12 mm #16	8x r37 6,7/7,8	22x r42 20/11	8x r50	10x s68 Ø 20mm	1x z1 4 mm	1x n26	1x p38 Ø3.5x16 mm	

1 

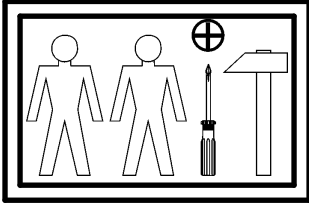
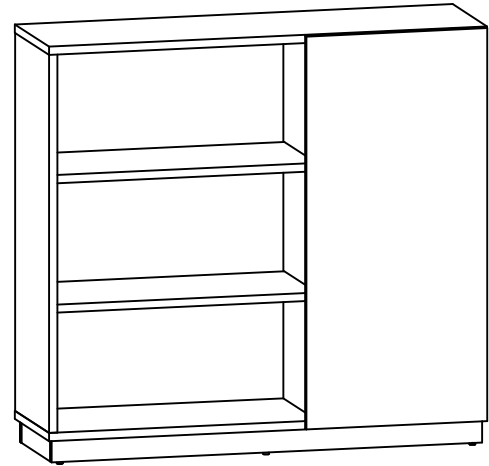
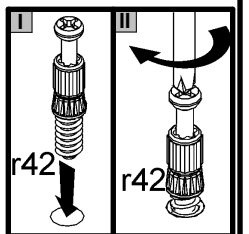
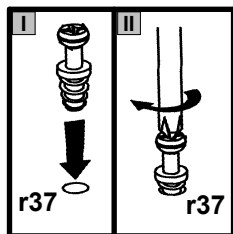
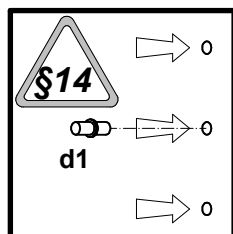
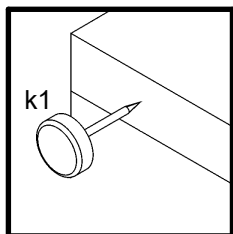
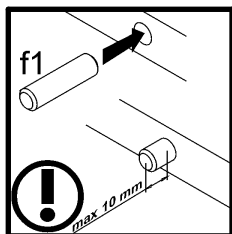
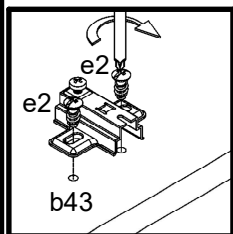
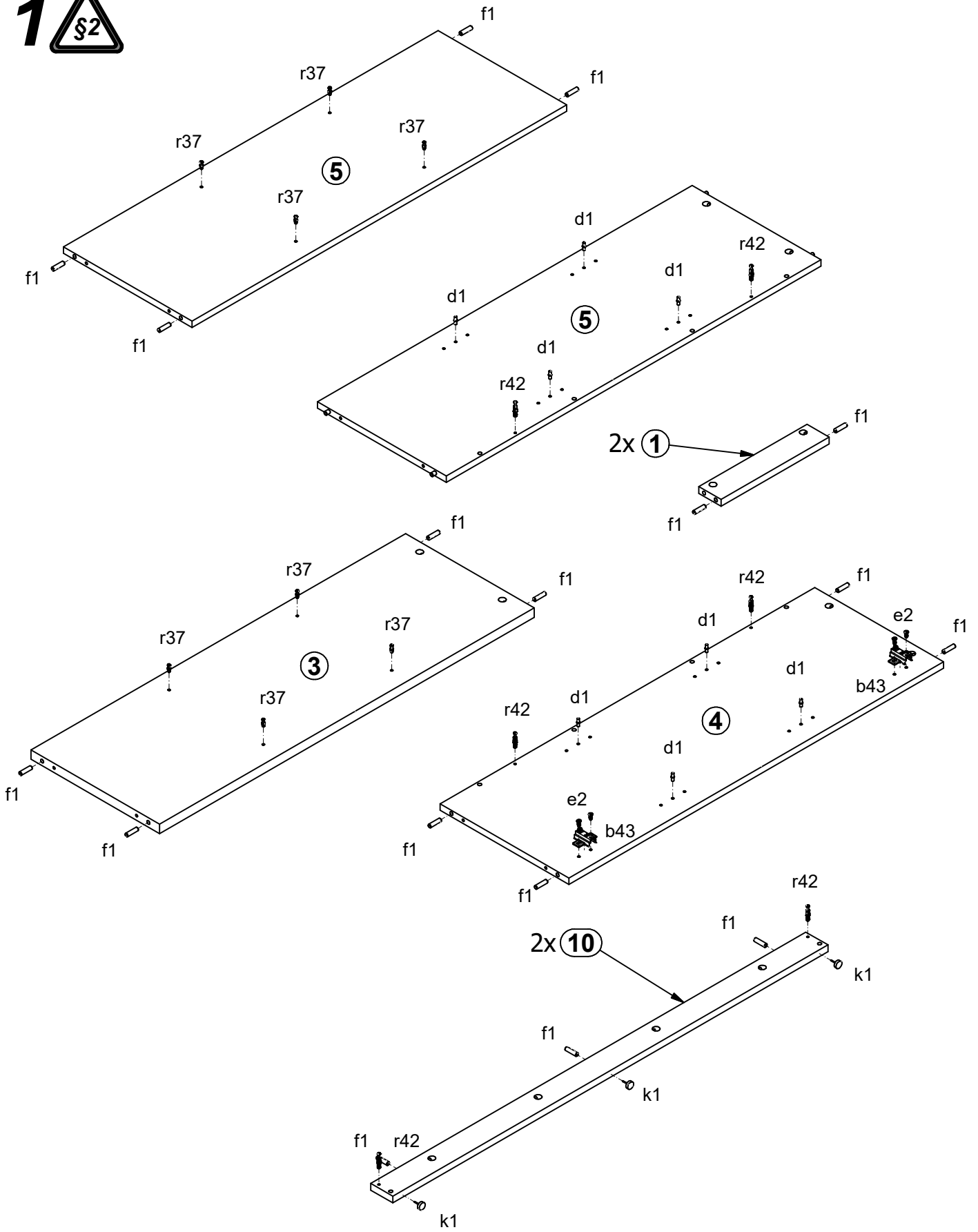

2

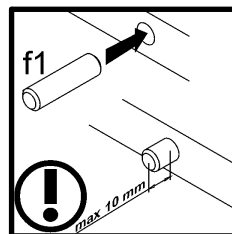
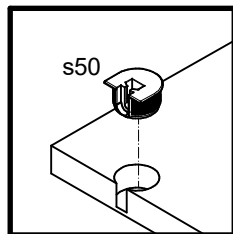
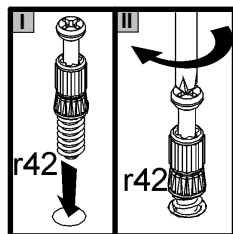
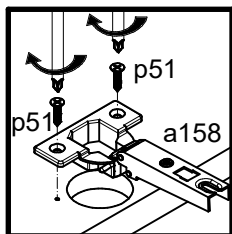
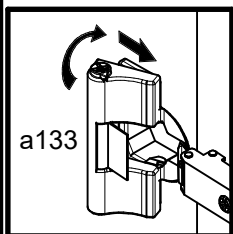
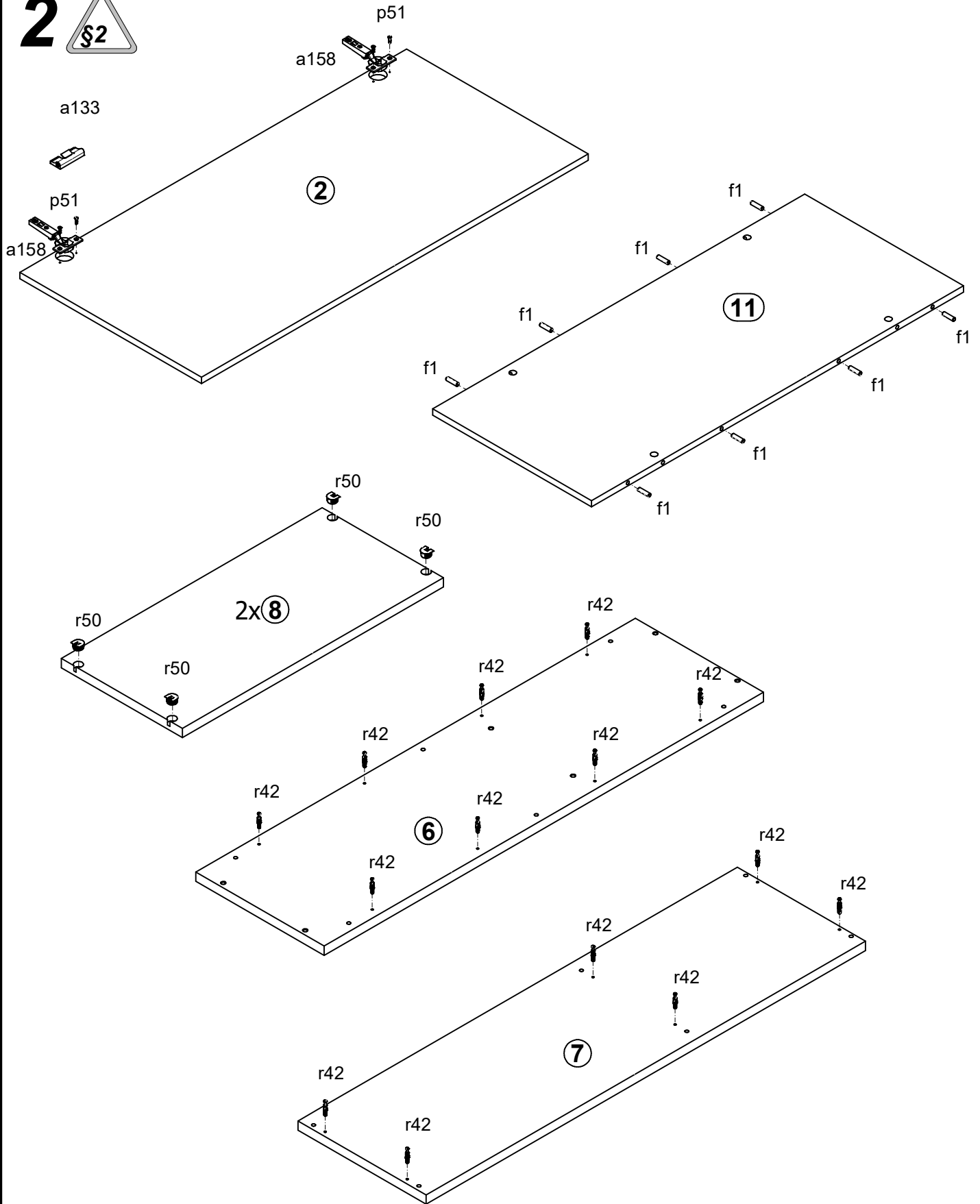

3

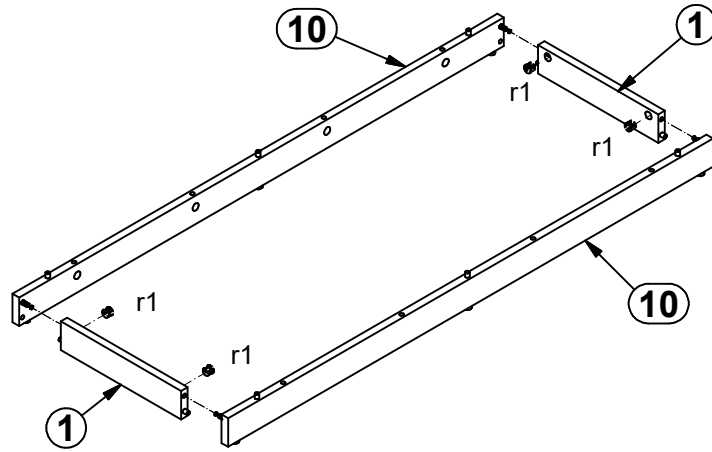

4

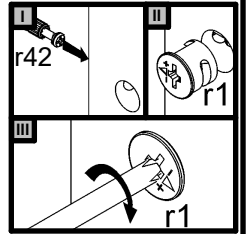
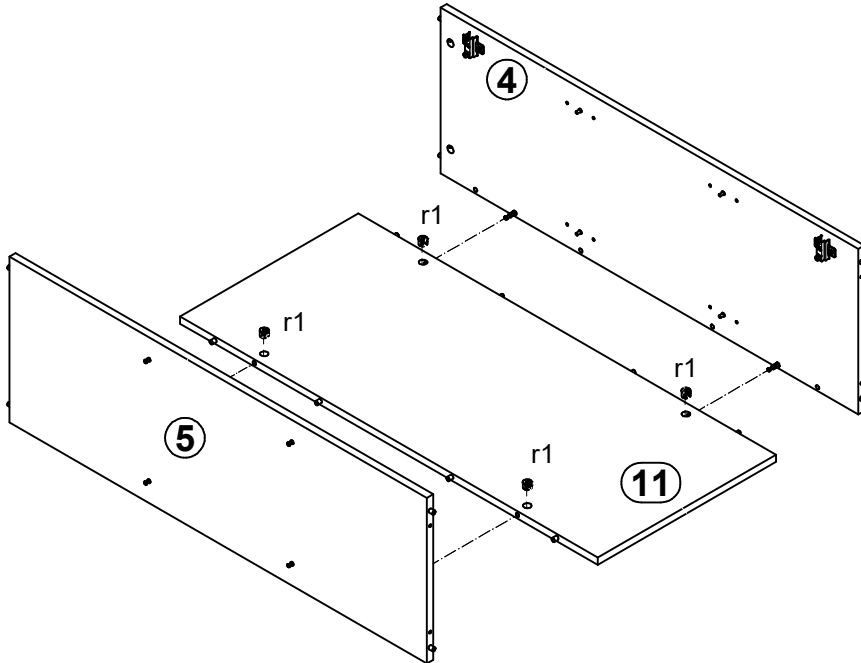

5

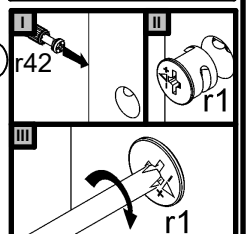
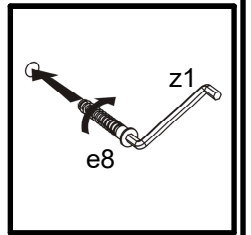
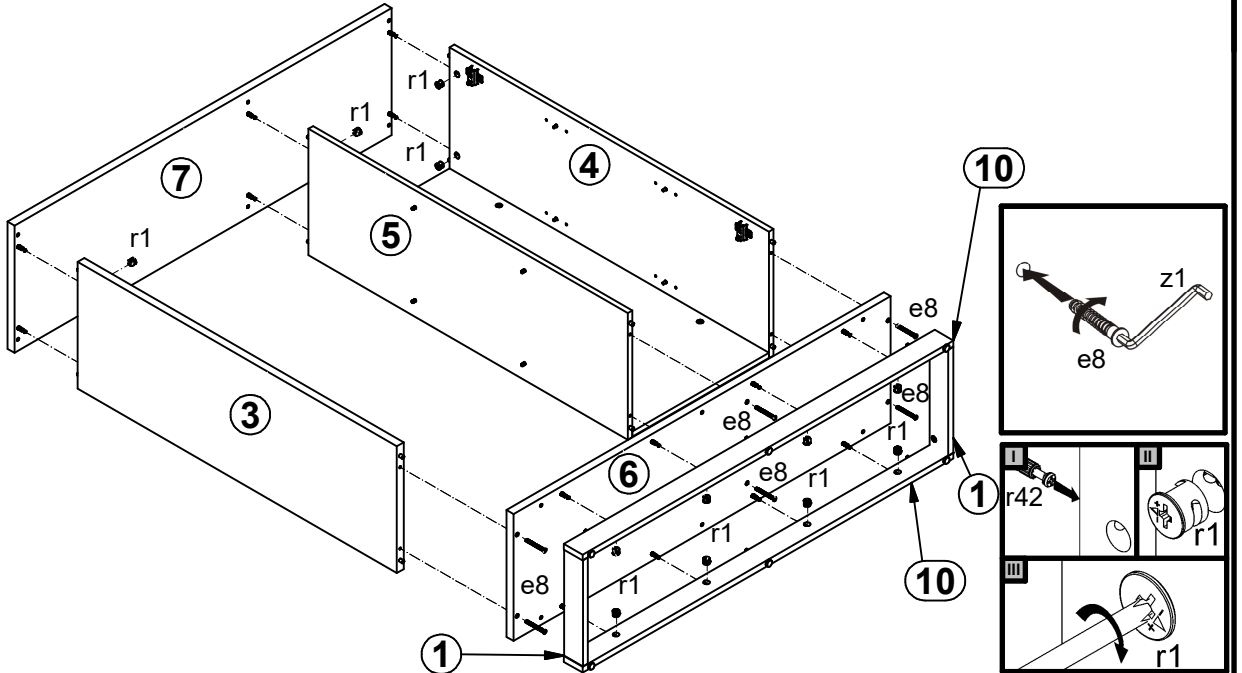

6

