

A

AROSA

S346-REG2W

A	B	C	D
1	S346-0013	397	300
2	S346-0014	397	176
3	S346-0015	397	534
4	S346-0016	1386	471
5	S346-0017	1386	471
6	S346-0025	397	300
7	S346-0026	397	176
8	S346-0027	397	534
9	S346-1007	1486	400
10	S346-1008	1486	400
11	S346-3008	950	399
12	S346-3009	950	356
13	S346-3010	950	356
14	S346-3011	949	351
15	S346-9304	1416	973

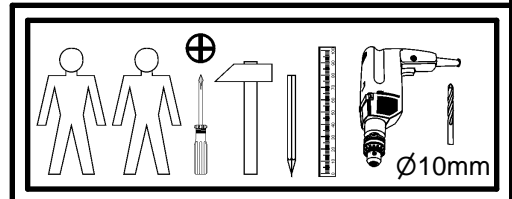
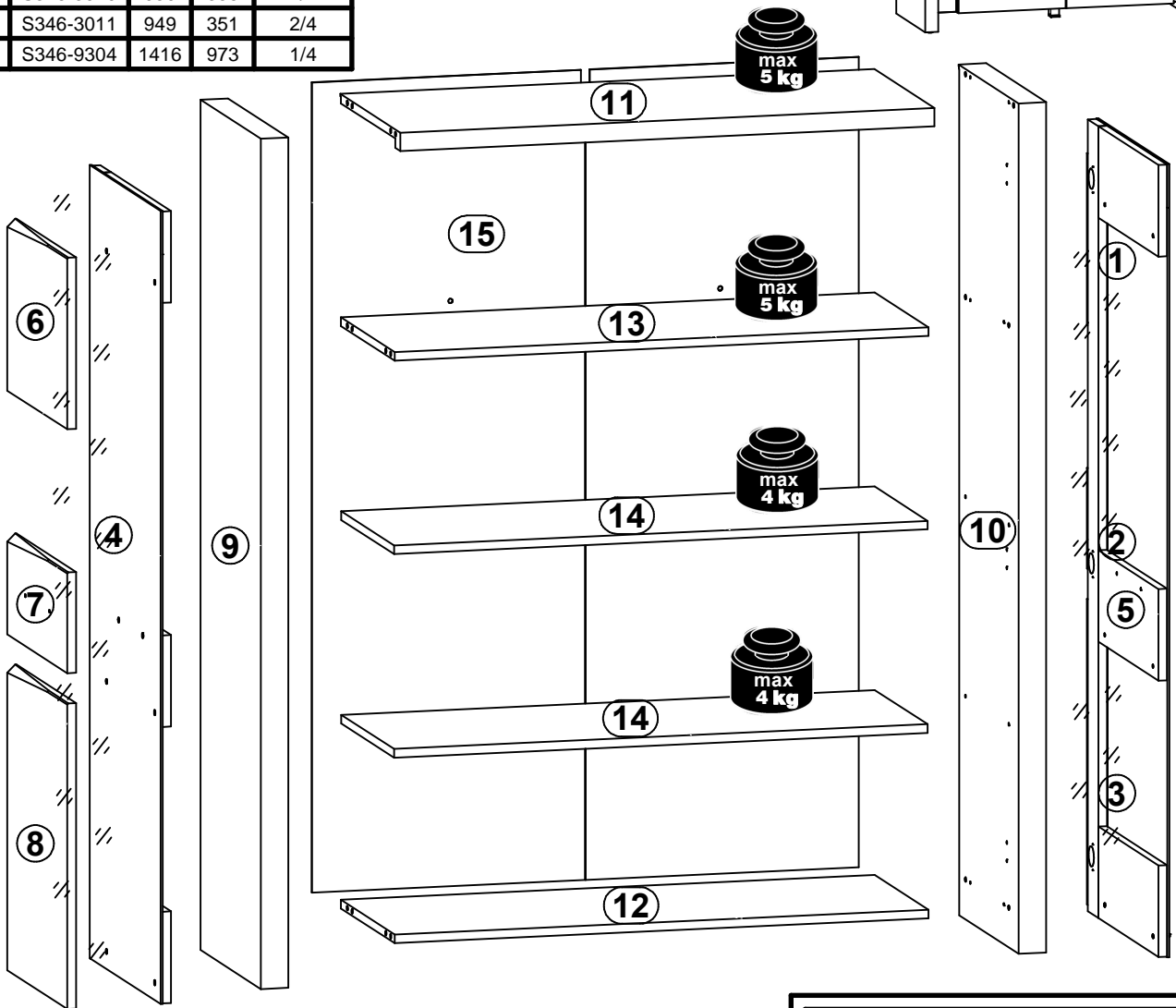
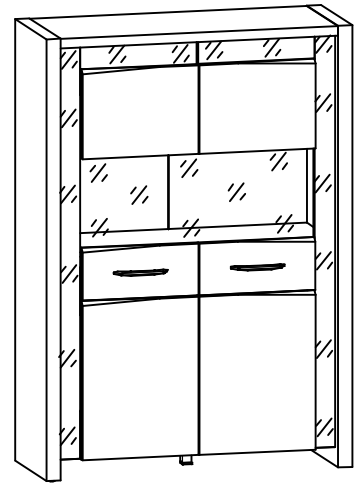

2x K16 a43	4x K16, Ø55 a101	2x D5 b19	4x D2 b59	2x c433/1	8x d1	1x e2	12x e16	12x f1
4x M4x40 mm j40	4x k1	1x 42.5x42.5/4 mm k38/3	1x 30x30/60 mm k38/8	60x l1	1x 86x21x15/1.5 n14/2	2x 2x1.8W o60/1	2x o60/2	1x o60/3
6x Ø3.5x16 mm p38	12x Ø3.5x15 mm p51	4x Ø2x8 mm p123	12x Ø15x12 mm #16 r1	12x 20/11 r42	12x Ø12x0.5 mm s59	8x Ø20mm s68	1x f35	1x Ø5x60 mm p17

1 

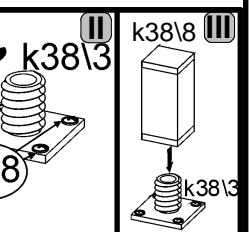
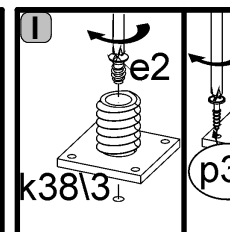
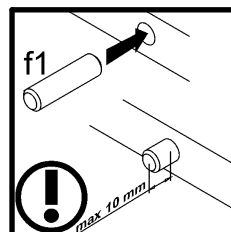
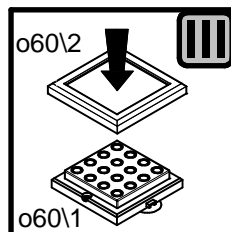
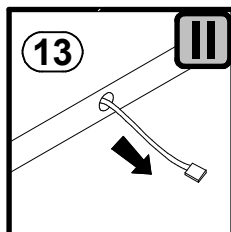
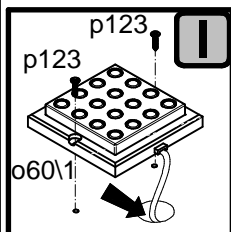
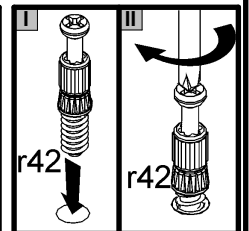
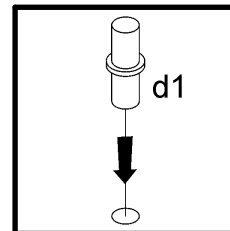
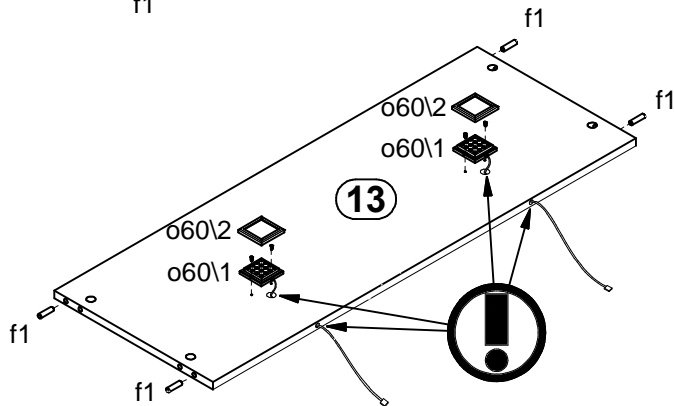
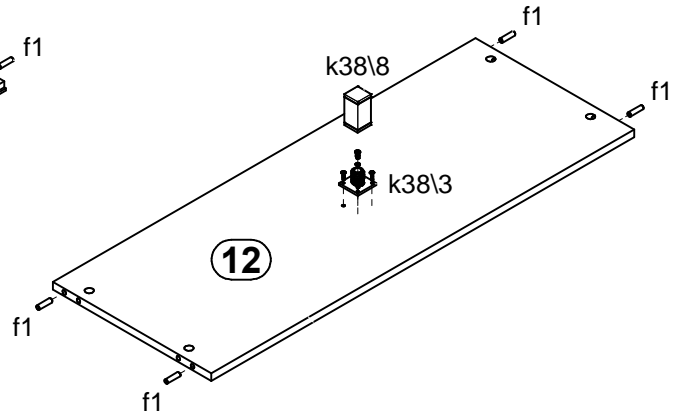
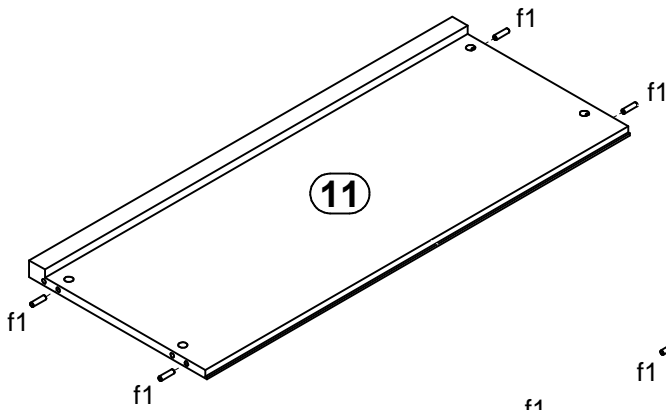
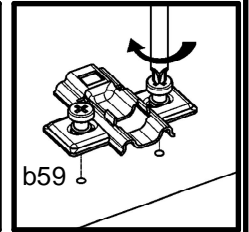
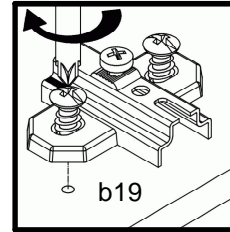
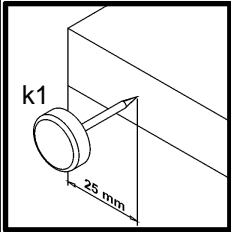
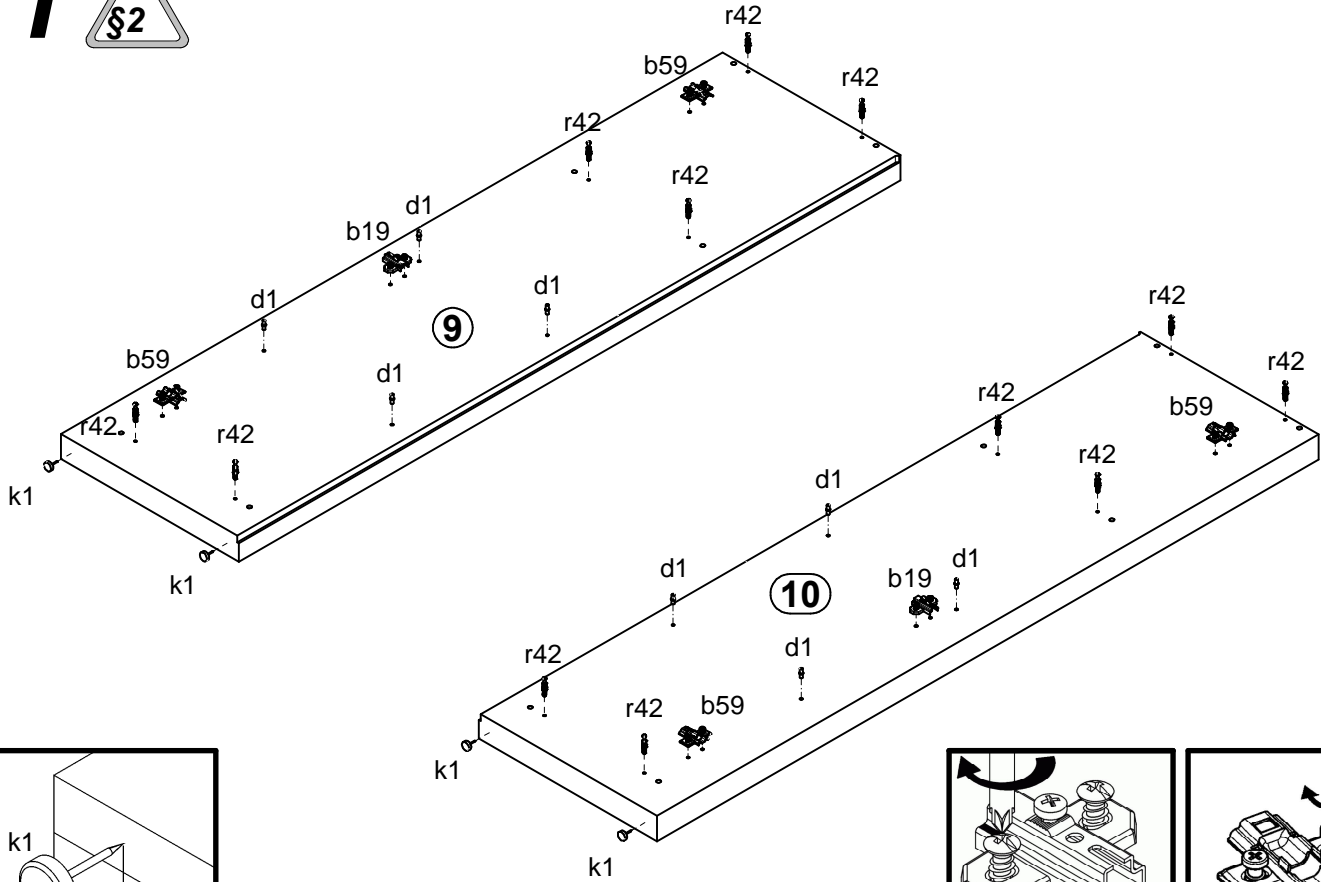

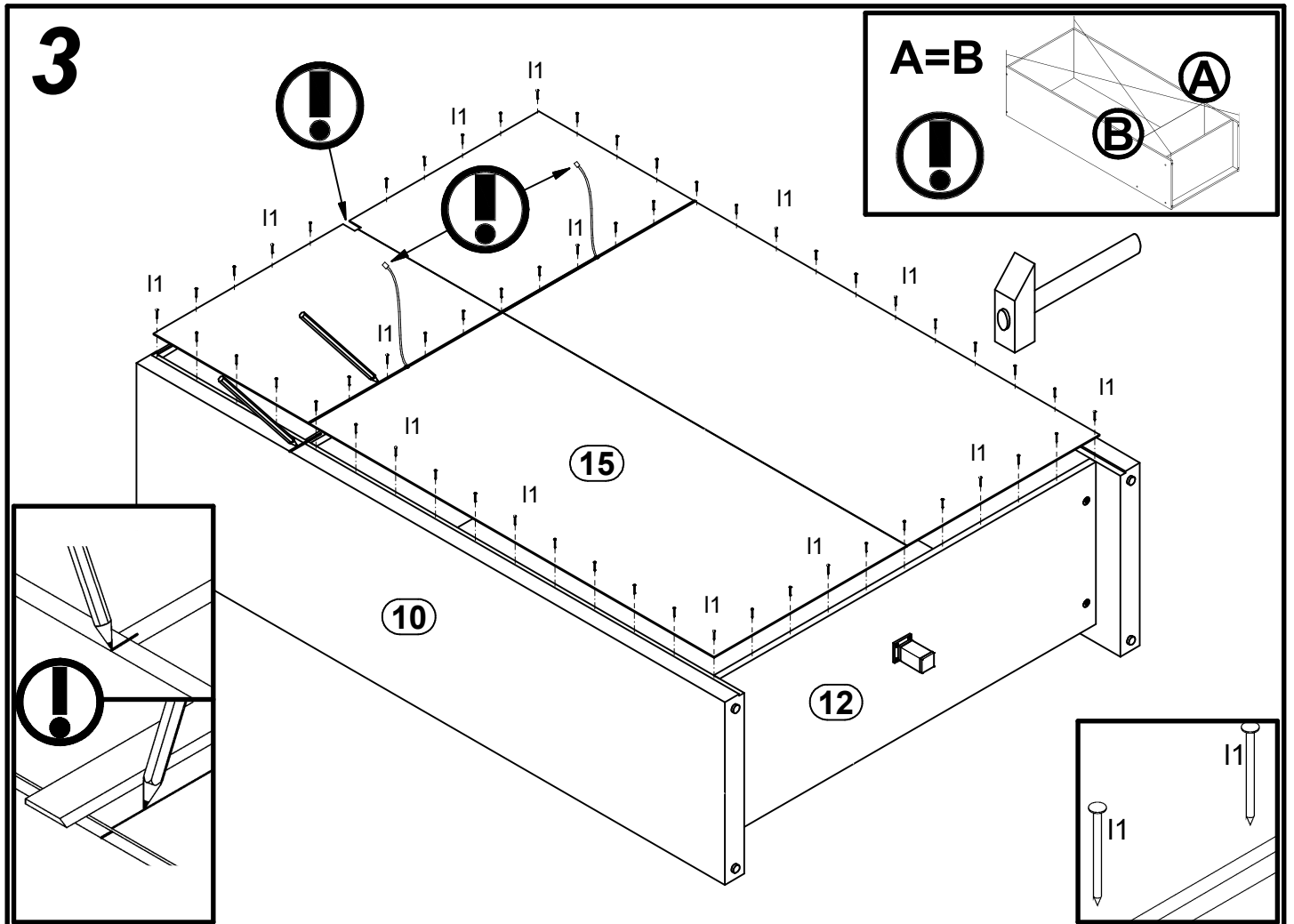
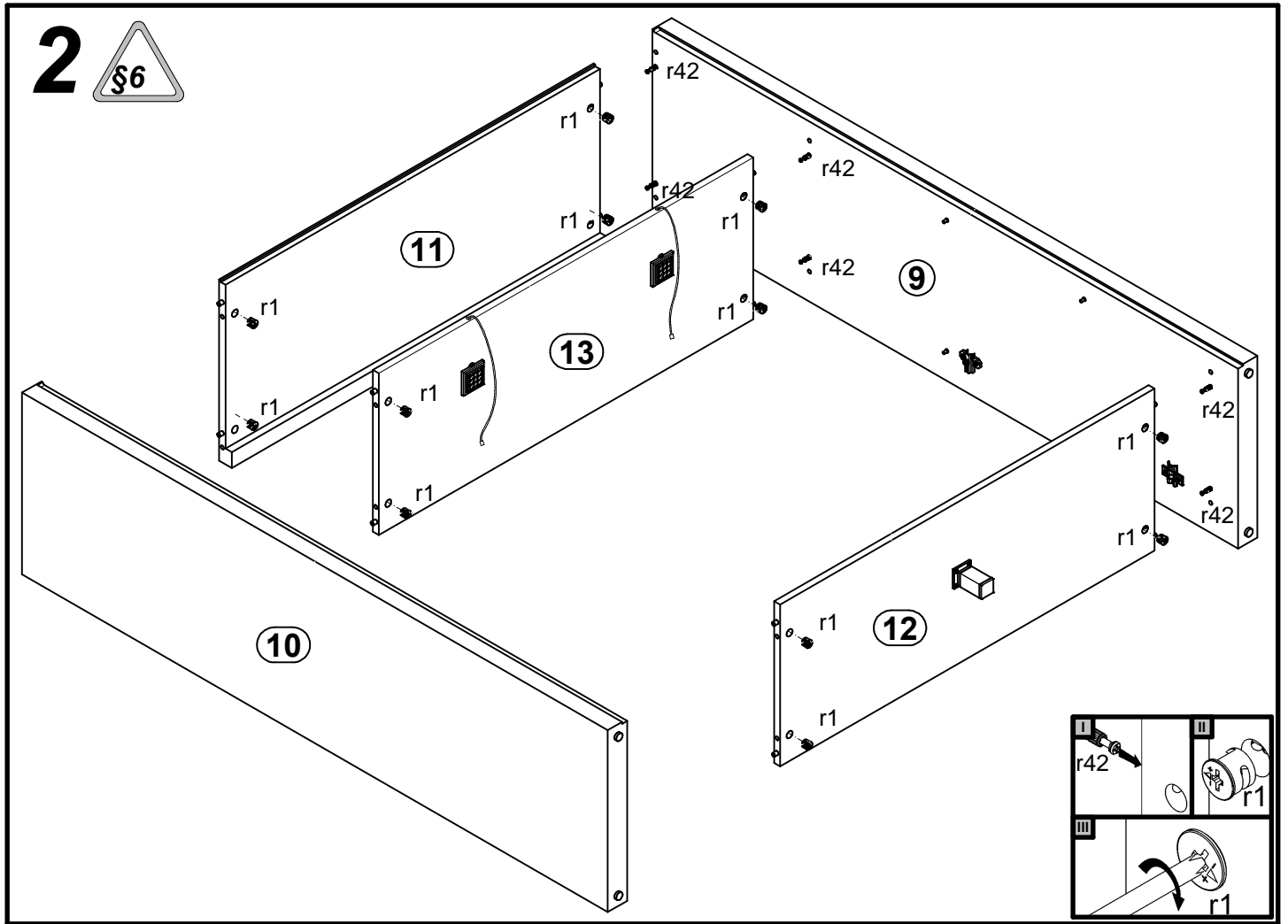

4

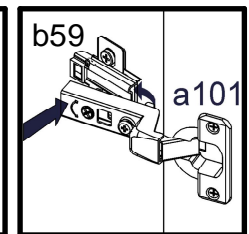
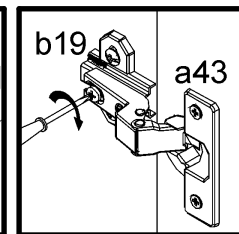
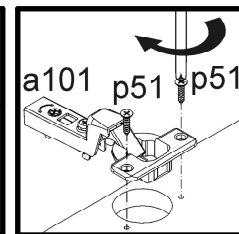
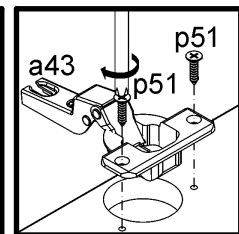
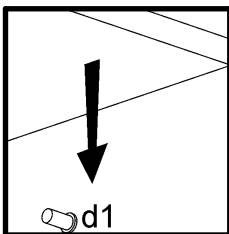
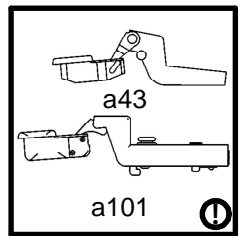
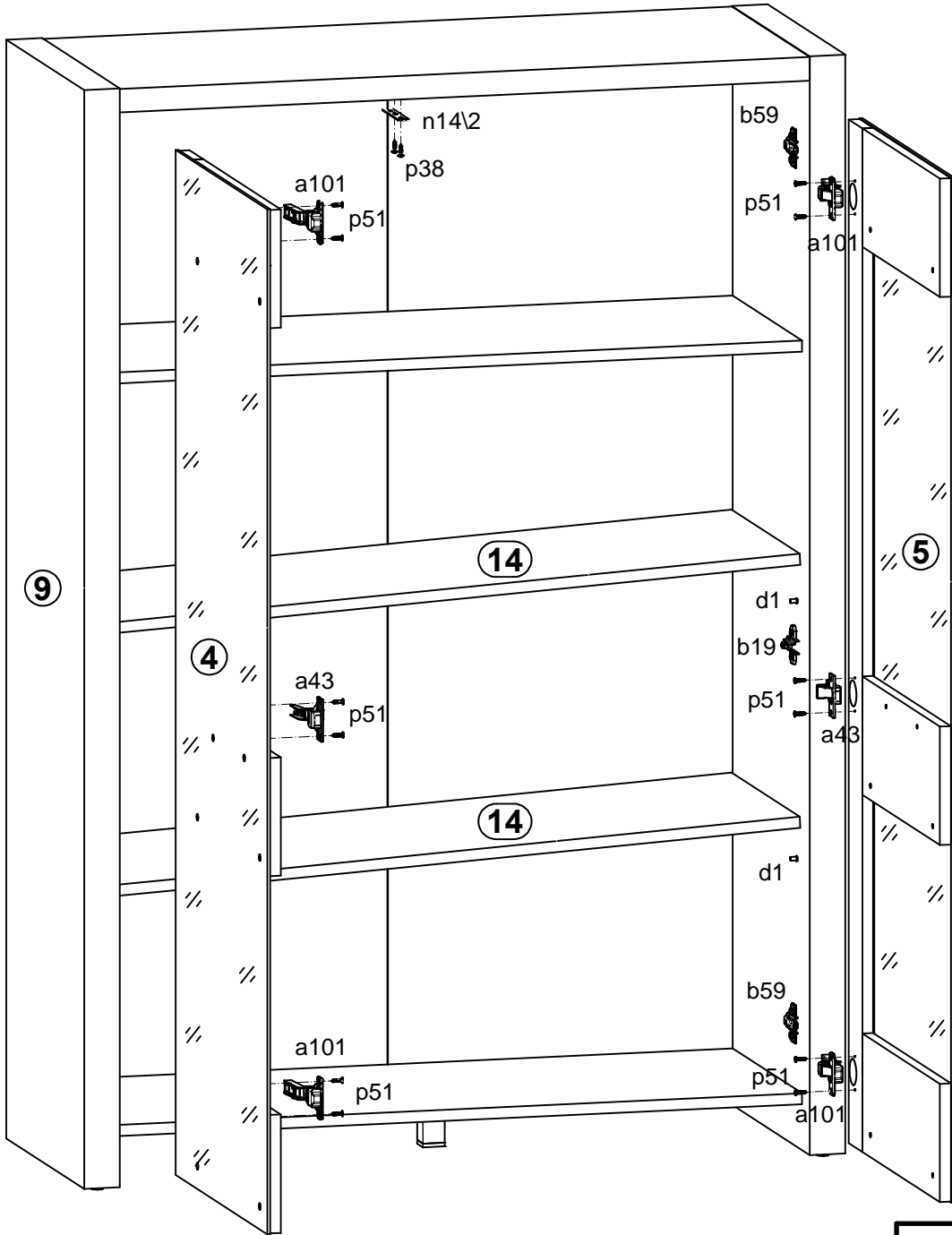
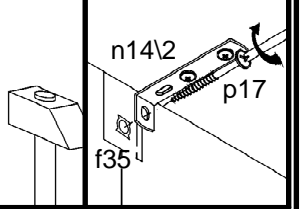
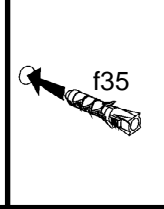
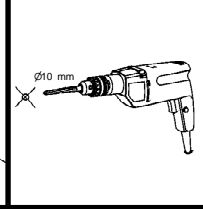
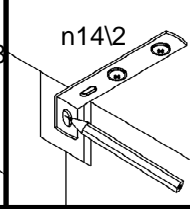
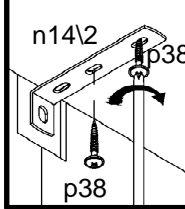

5

