

system TADEUSZ

T-25 lewa

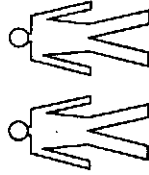

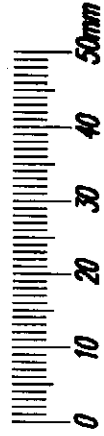



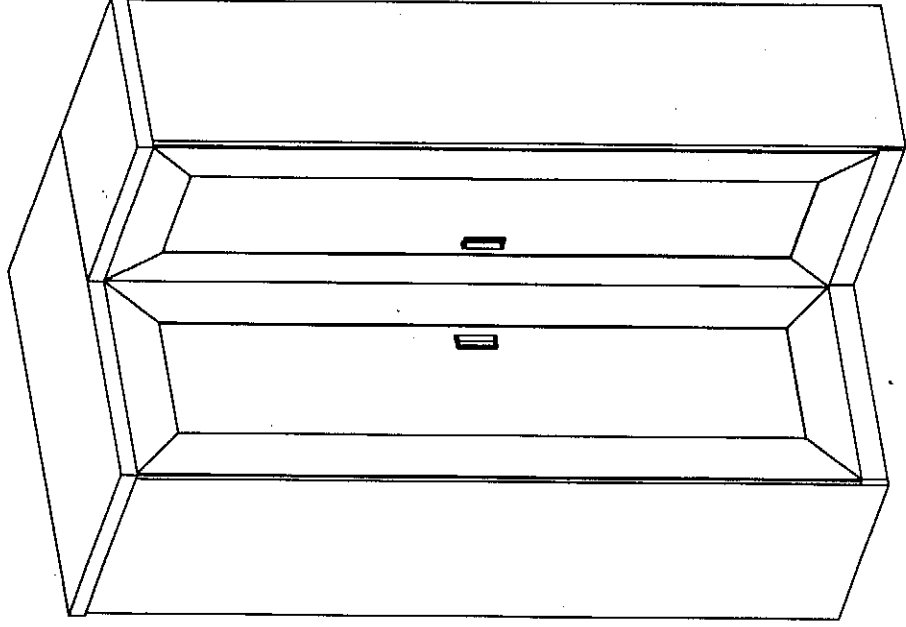
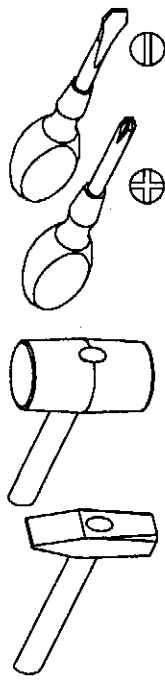



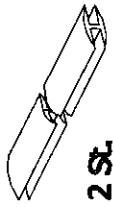
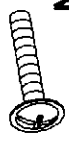
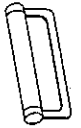

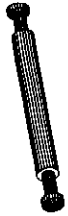

INSTRUKCJA MONTAŻU

Narzędzia potrzebne do montażu

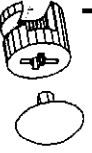

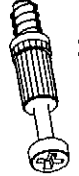
W przypadku reklamacji proszę o podanie numeru pakowacza znajdującego się na kartonie

 H - 2 St.	 N - 4 St. M4 x 25 mm	 U - 2 St.	 G - 50 St. 3,5 x 16 mm	 T - 2 St.	 F - 6 St.
 W - 11 St.	 E - 100 St.	 C - 8 St.	 D - 8 St.	 S - 6 St.	 L - 25 St.
 P - 20 St.	 B - 26 St.	 K - 13 St.	 Z - 1 St.	 M - 1 St.	

I

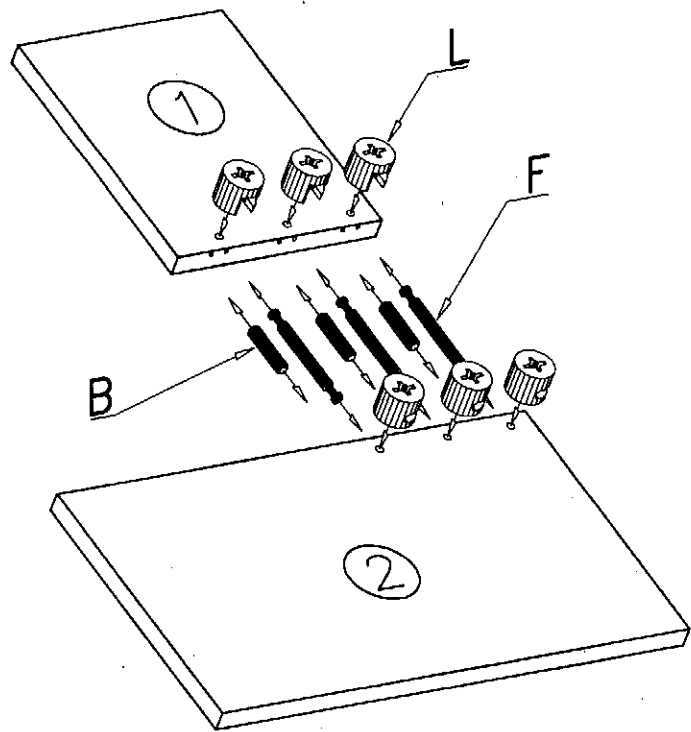

II

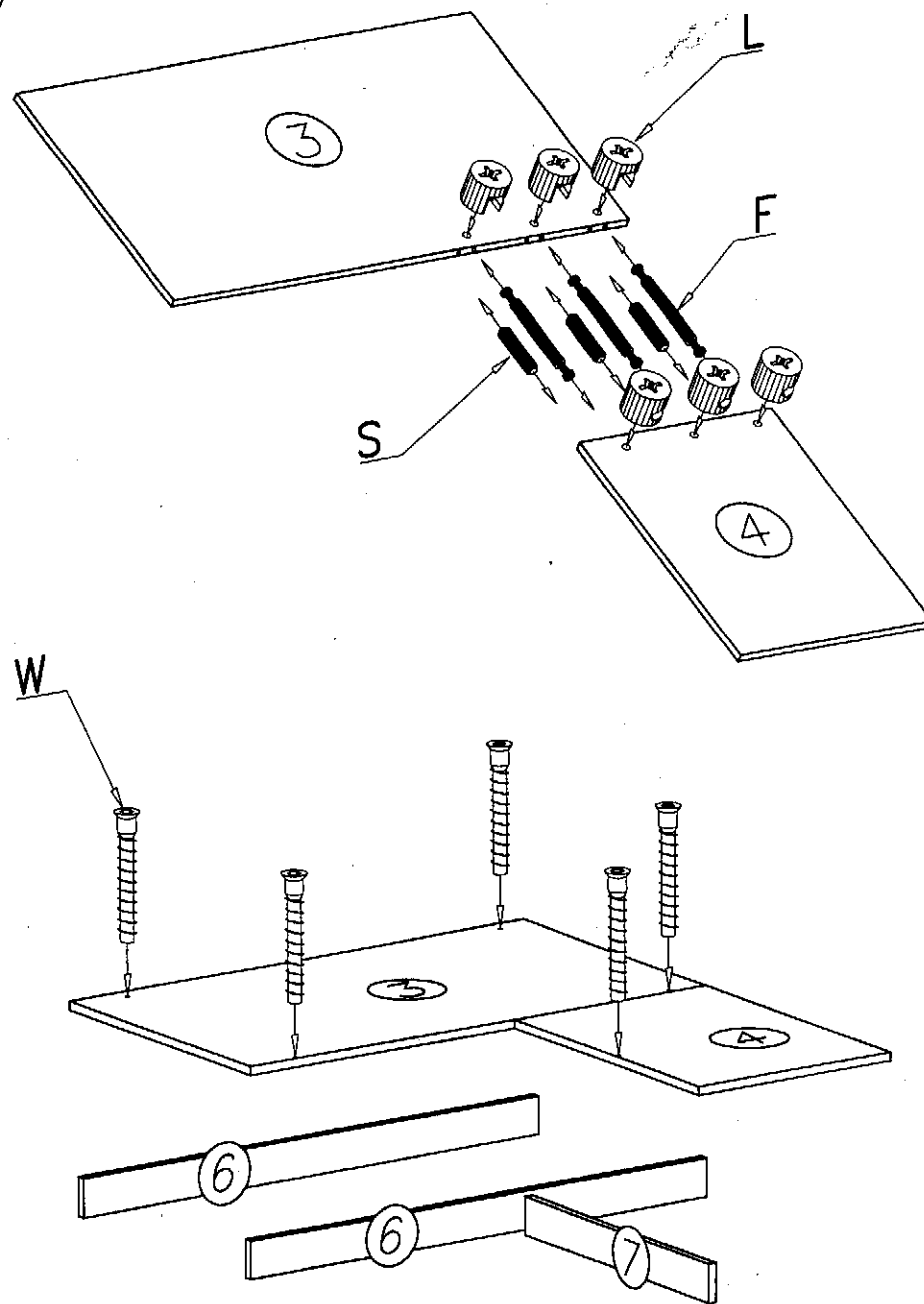

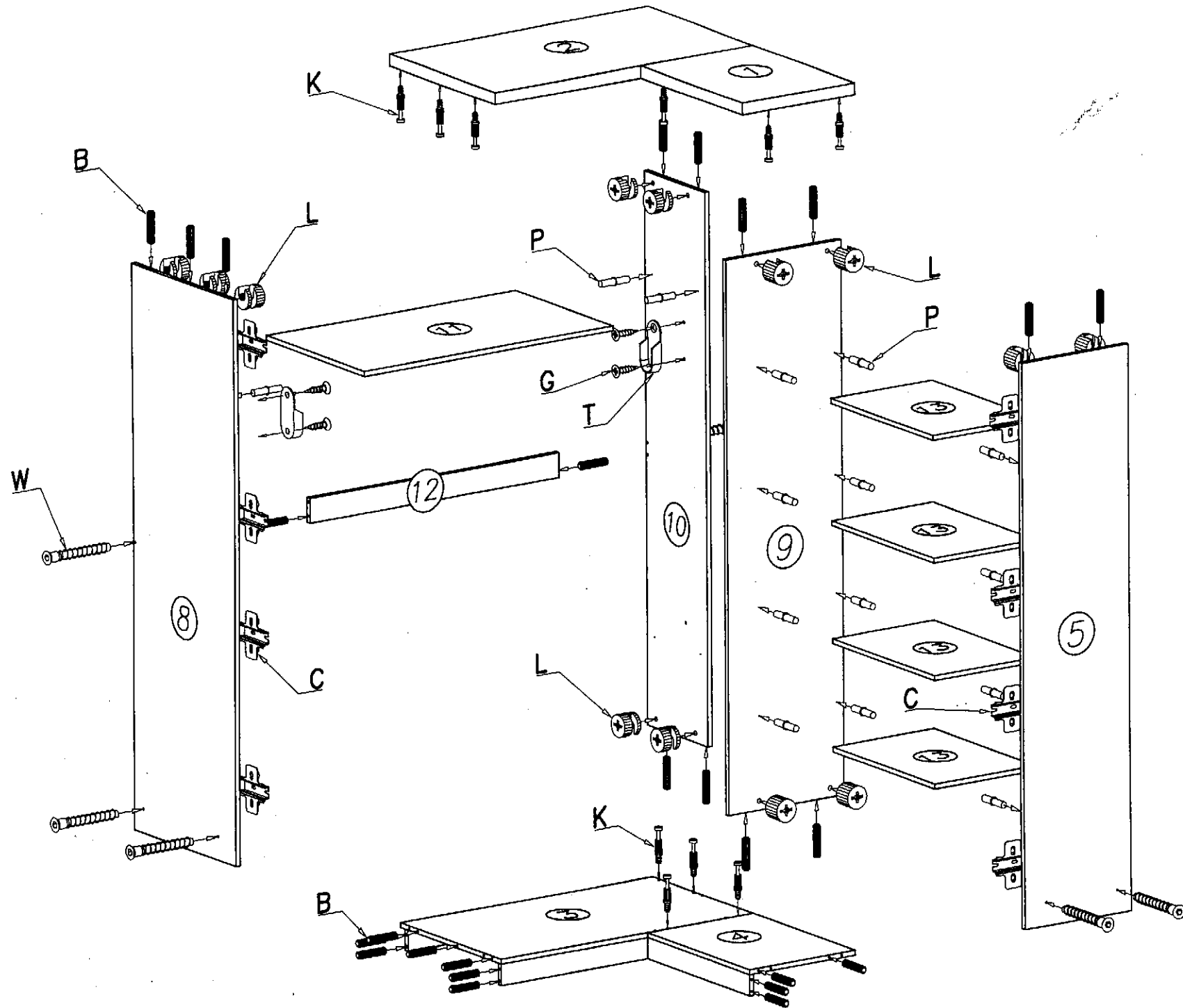

IV

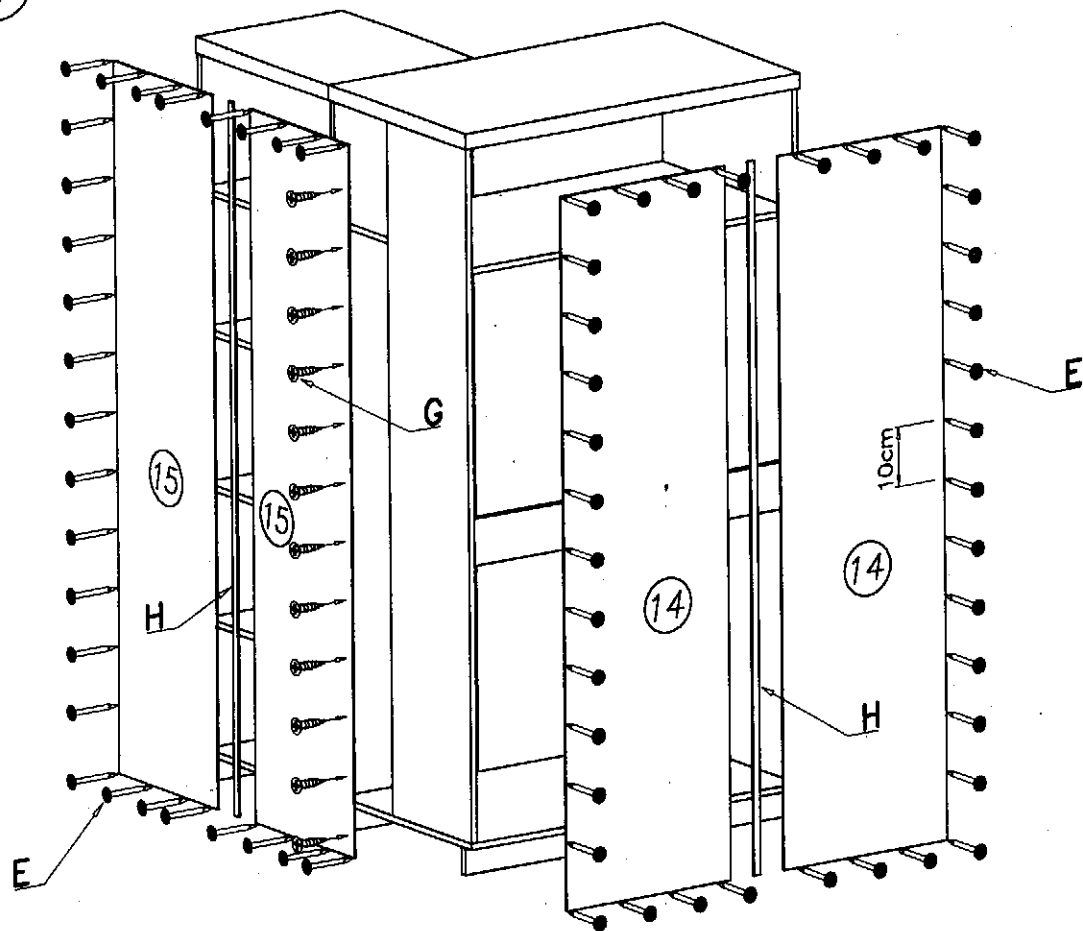

V

