

# KORA

# 5

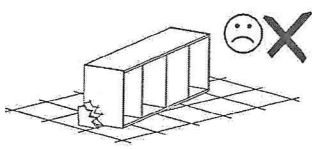

Narzędzia potrzebne do montażu

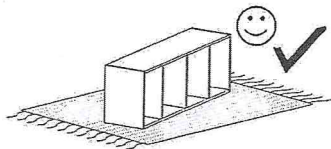
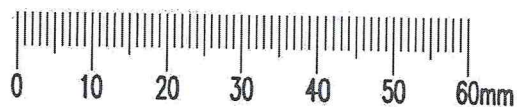
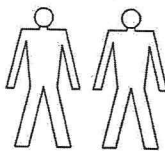
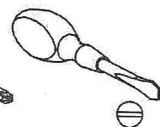
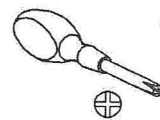
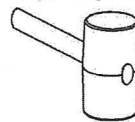
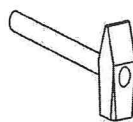

**UWAGA!**  
MONTOWANIE USZKODZONYCH  
ELEMENTÓW POWODUJE UTRATĘ  
GWARANCJI

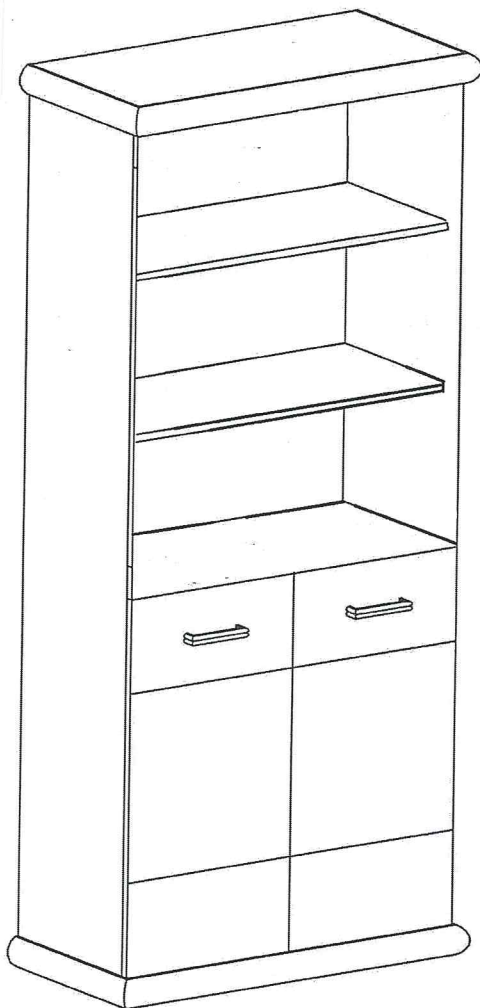

**UWAGA!**  
Mebel zawiera  
elementy drewniane

W przypadku reklamacji proszę o podanie numeru pakowacza znajdującego się na kartonie

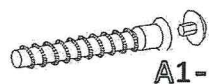

A1 - 4 St.  
A - 8 St.

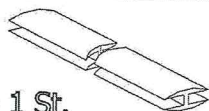

H - 1 St.

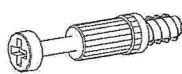

K - 8 St.

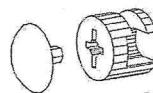

L - 8 St.

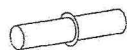

S - 12 St.

F - 4 St.

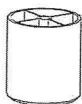

U - 2 St.



D - 4 St.

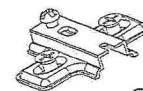

C - 4 St.



E - 90 St.



B - 8 St.



G - 8 St.  
3,5 x 16 mm



Z - 1 St.



N - 4 St.  
4 x 30 mm

1

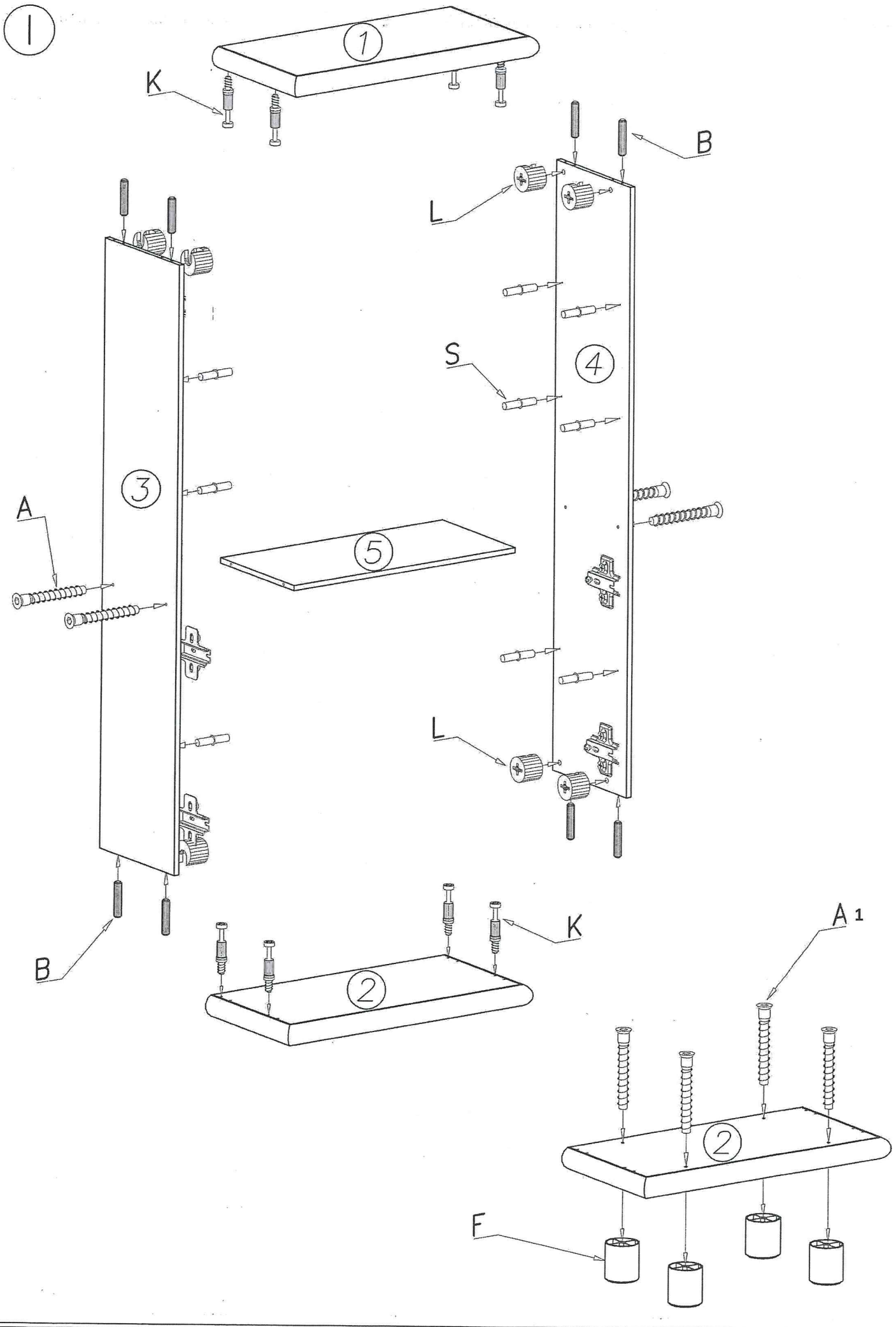

III

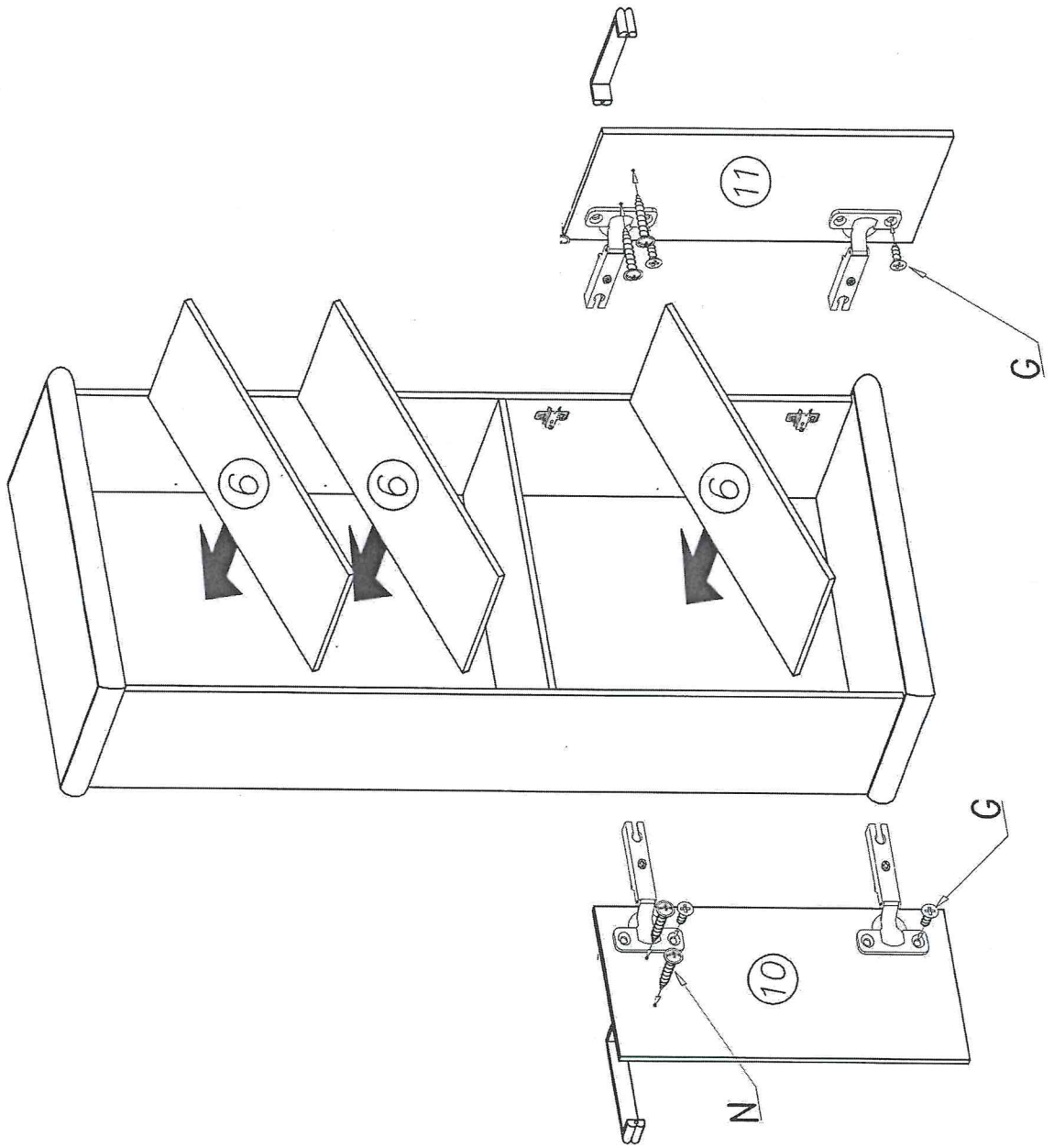

II

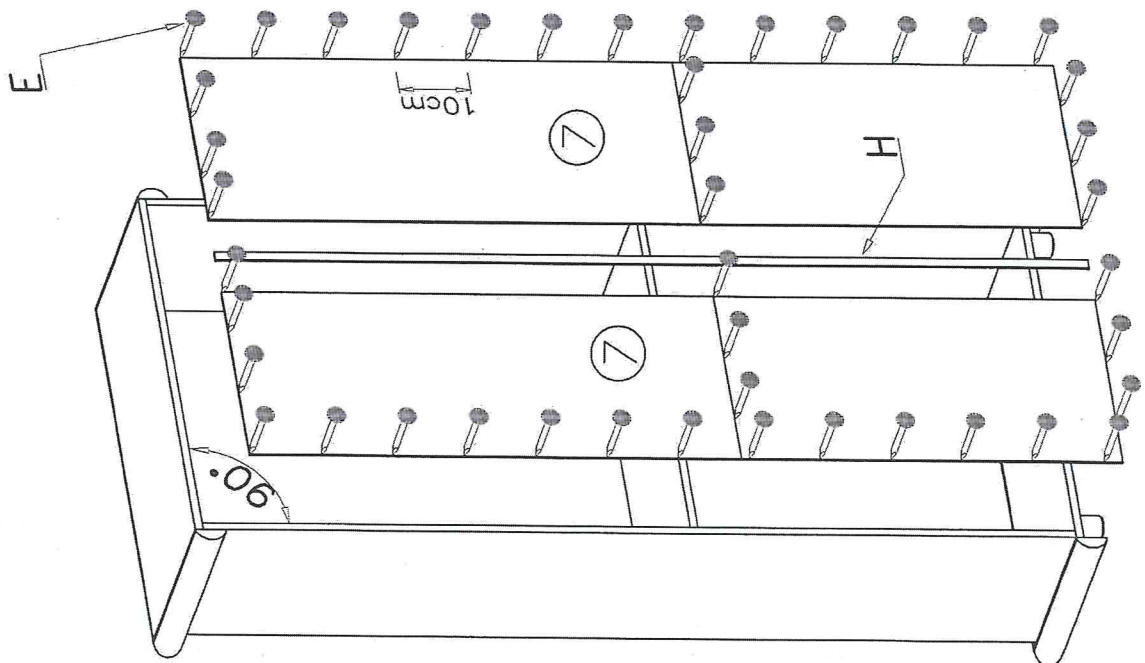

Meble zawierają elementy drewniane , których barwa i układ słoików są uzależnione od wielu czynników, dlatego mogą występować różnice w fakturze i barwie co nie stanowi wady produktu i nie wpływa na jego trwałość i funkcjonalność.

Listwy drewniane mogą ujawniać niewielkie zmiany w kształcie i wymiarach wywołane specyficznymi warunkami eksploatacji – wilgotność, różnice temperatur etc.