

- (D)** Montageanleitung
- (NL)** Handleiding voor de montage
- (TR)** Montaj talimatı
- (FR)** Instructions de montage
- (CZ)** Montážní návod
- (HU)** Összeszerelési útmutató
- (GB)** Assembly instructions
- (PL)** Instrukcja montażu
- (RU)** Инструкция по монтажу
- (IT)** Istruzioni di montaggio
- (RO)** Instructiuni de asamblare
- (SK)** Montážny návod

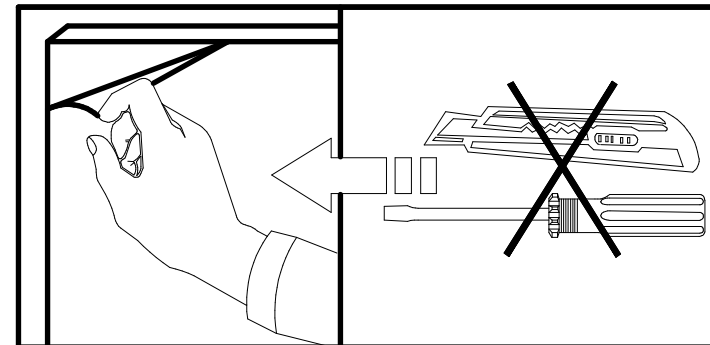

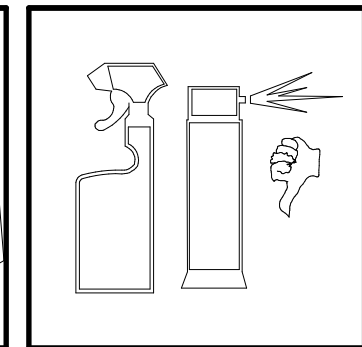

| A | B        | C (mm) |      | D   |
|---|----------|--------|------|-----|
| 1 | S205-309 | 1494   | 180  | 1/1 |
| 2 | S205-402 | 200    | 1500 | 1/1 |

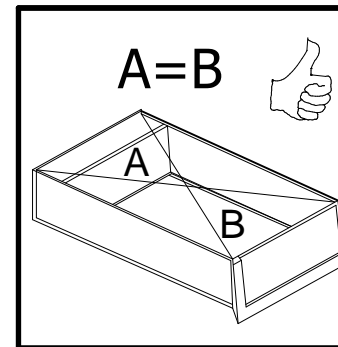
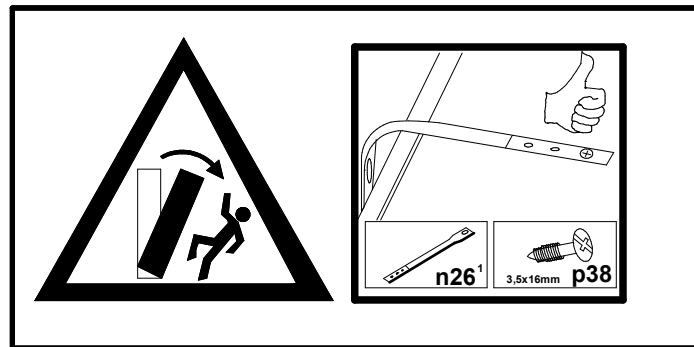
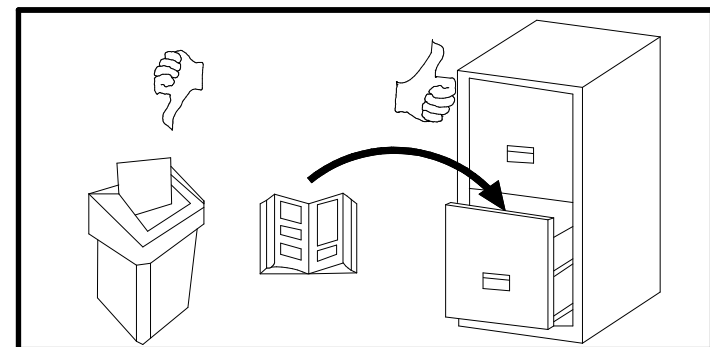
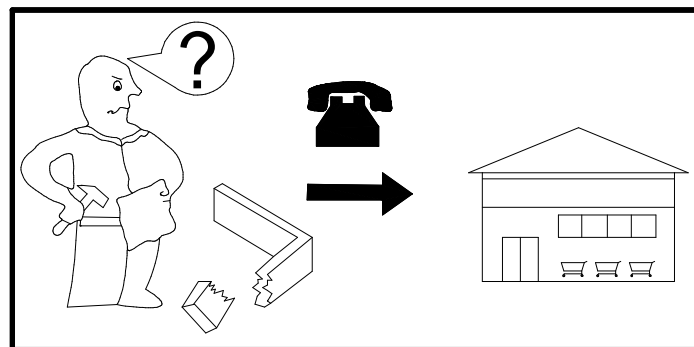
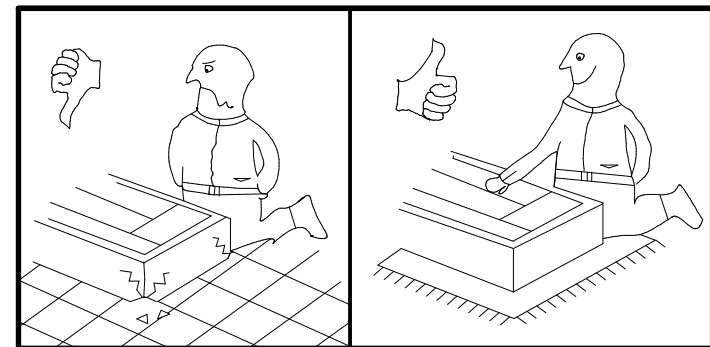
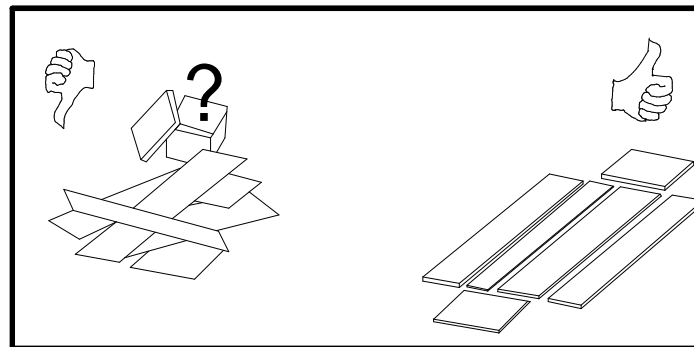
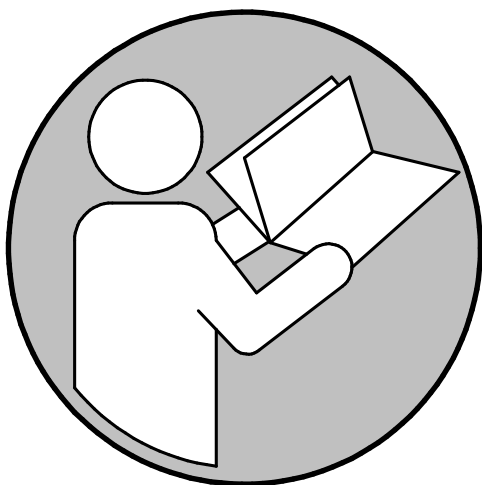
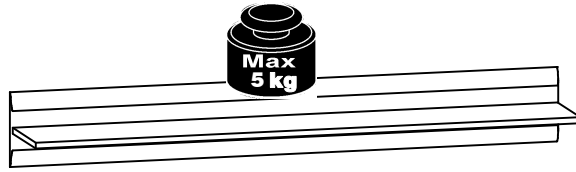
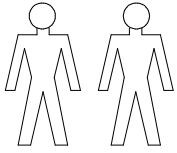
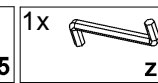
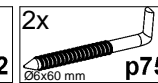
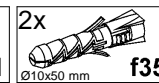
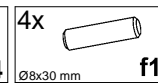
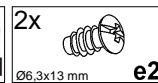
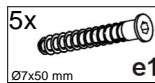
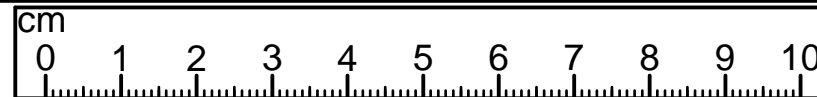
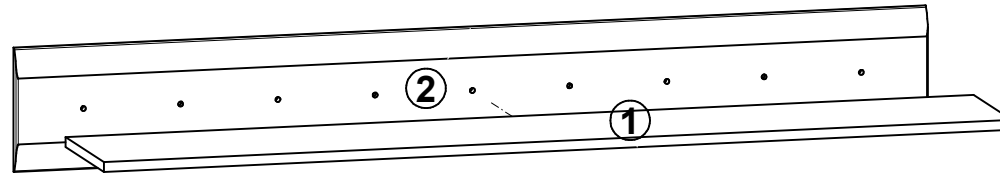
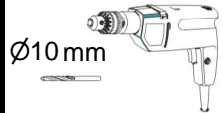
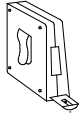
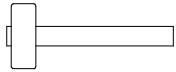
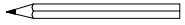
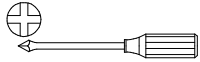
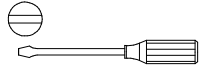

1 §2

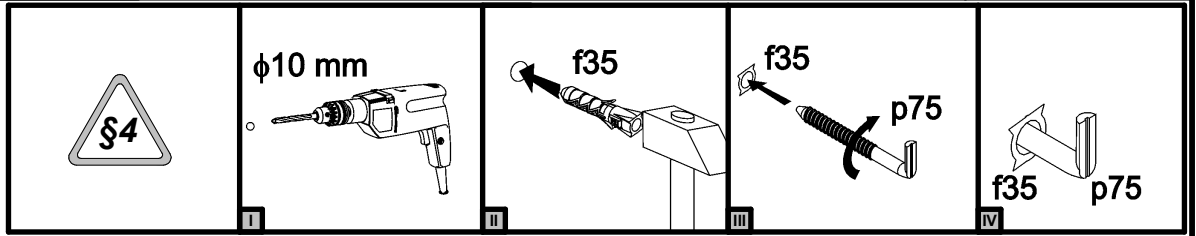
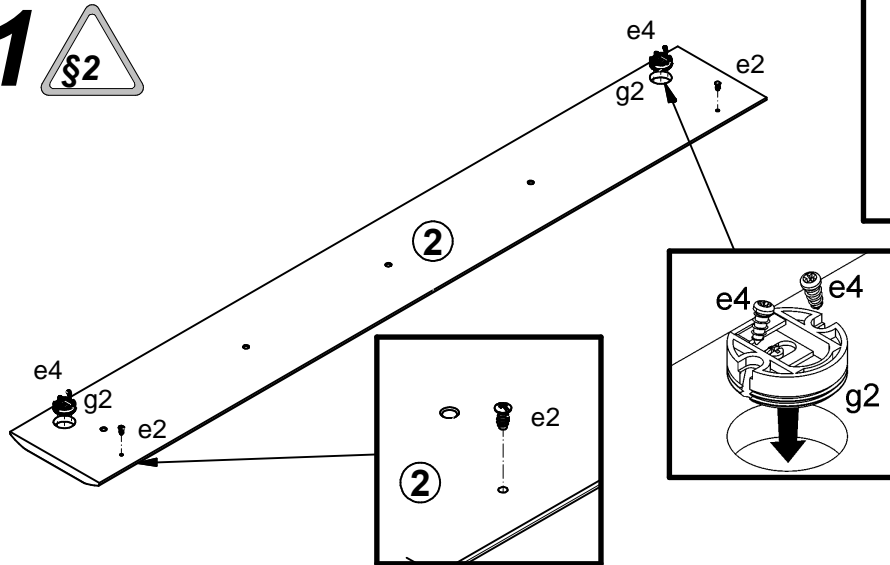

3

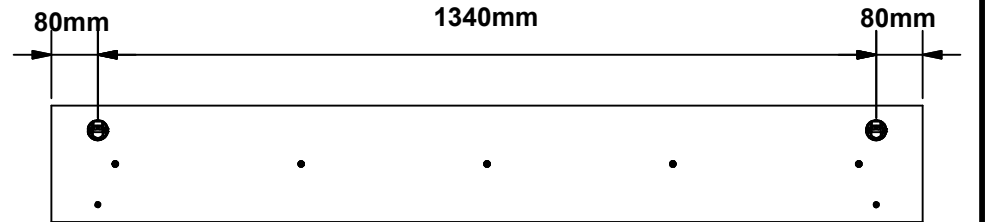

2 §6

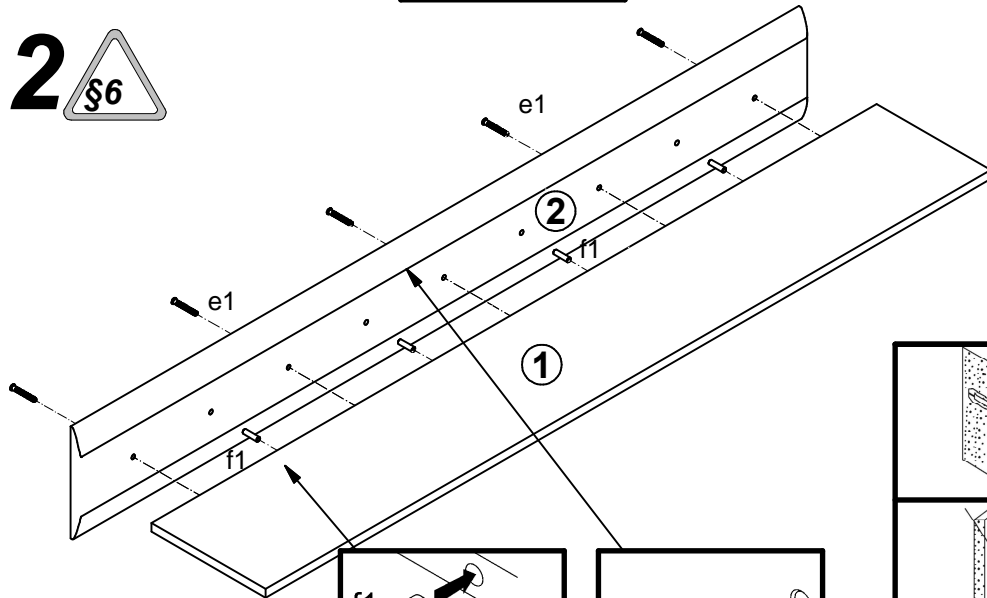

4

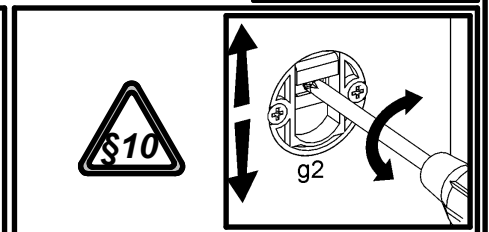
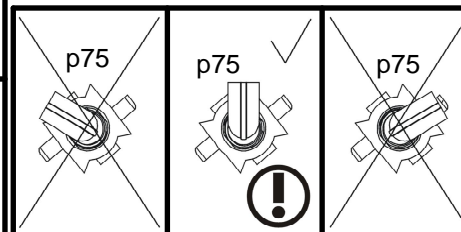
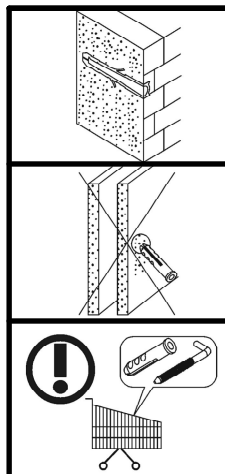
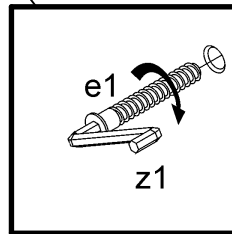
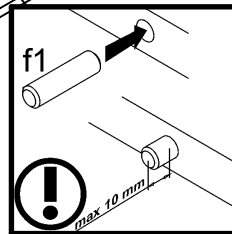
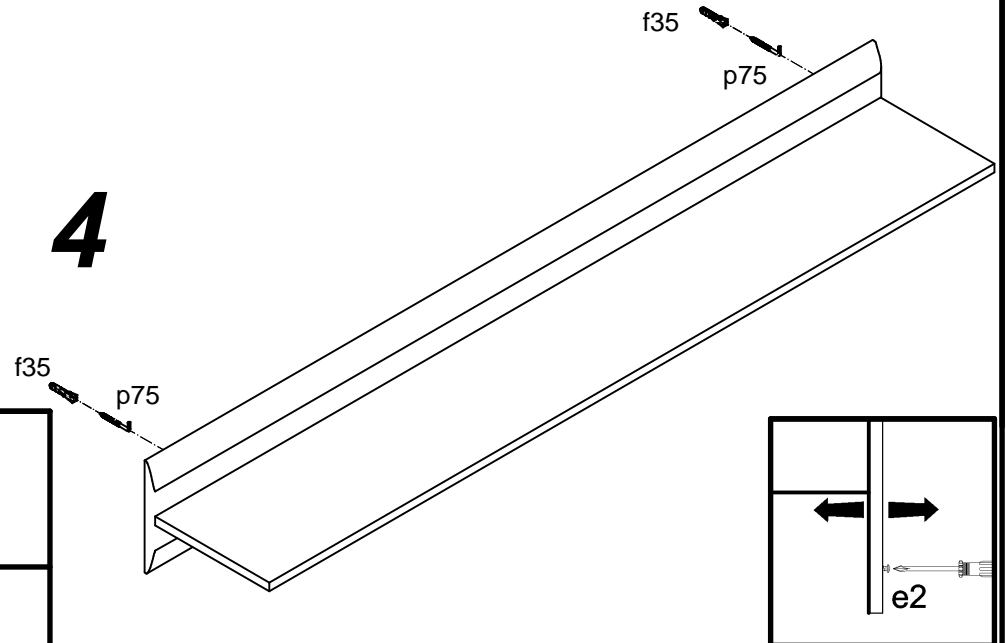

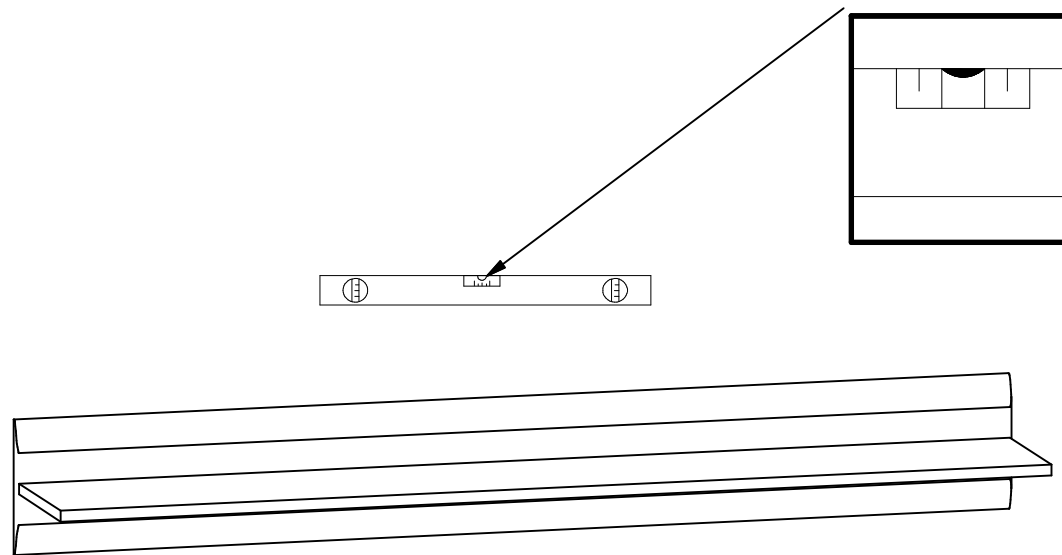
**5****Pflegehinweis!**

Bitte nur mit einem Staubtuch  
(kein Microfasertuch) oder  
einem feuchten Lappen reinigen.  
KEINE scheuernden Putzmittel  
verwenden!

**Wskazówka dotycząca pielęgnacji!**

Proszę czyścić tylko suchą lub lekko  
wilgotną szmatką do kurzu. Nie używać  
żadnych środków szorstkich!