

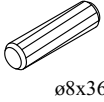

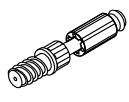

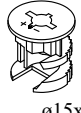



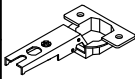
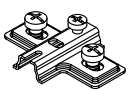

40 min

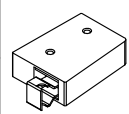
A1 X12  ø8x36	B4 X12 	B5 X12  ø15x12	G5 X12 	E1 X4  H=0	E2 X4  H=0
G21 X2 	ZR1 X3 	KR2 X3 	S1 X10 	D7 X6  USØ3x16	D6 X6  USØ3,5x30
D10 X14  USØ3,5x13	G2 X1 	T0 X1 			

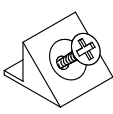

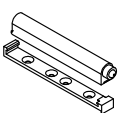
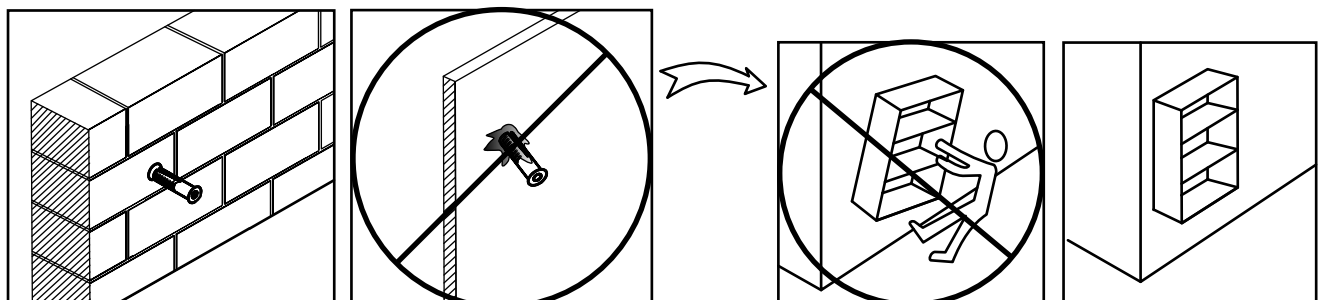
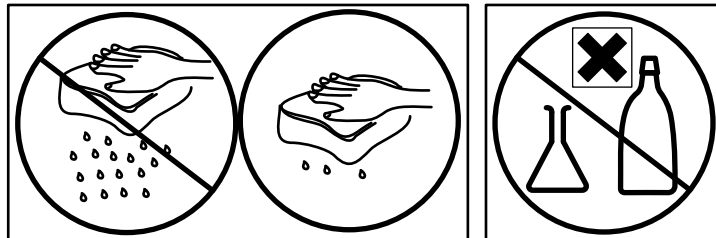
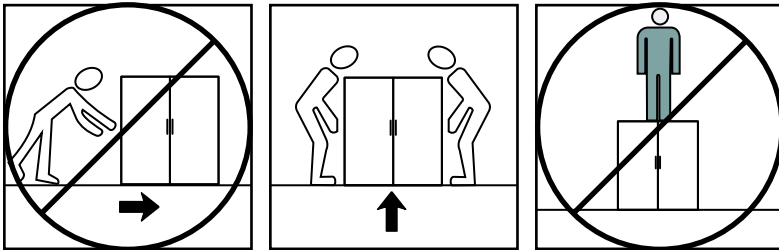
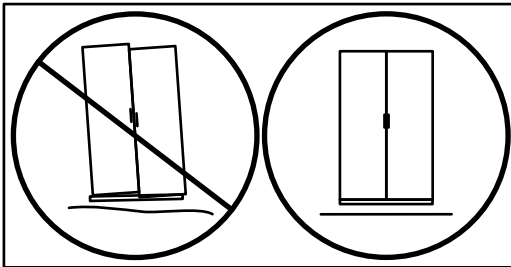
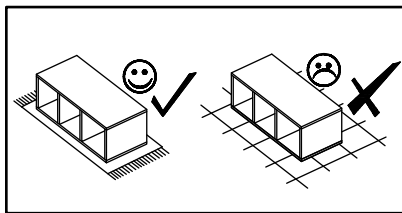
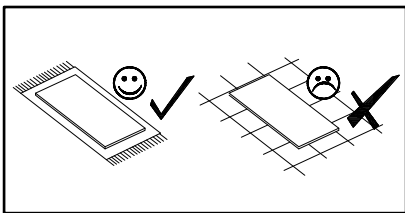
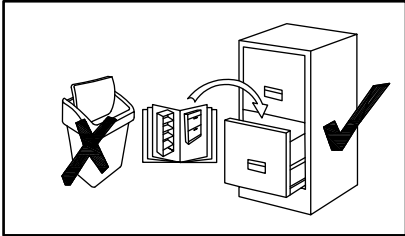
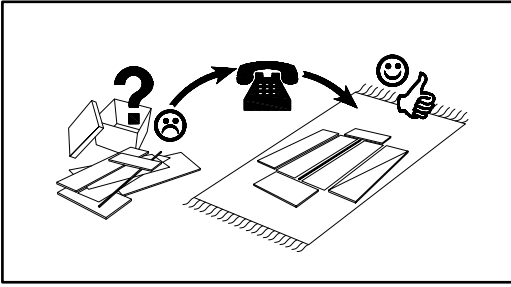
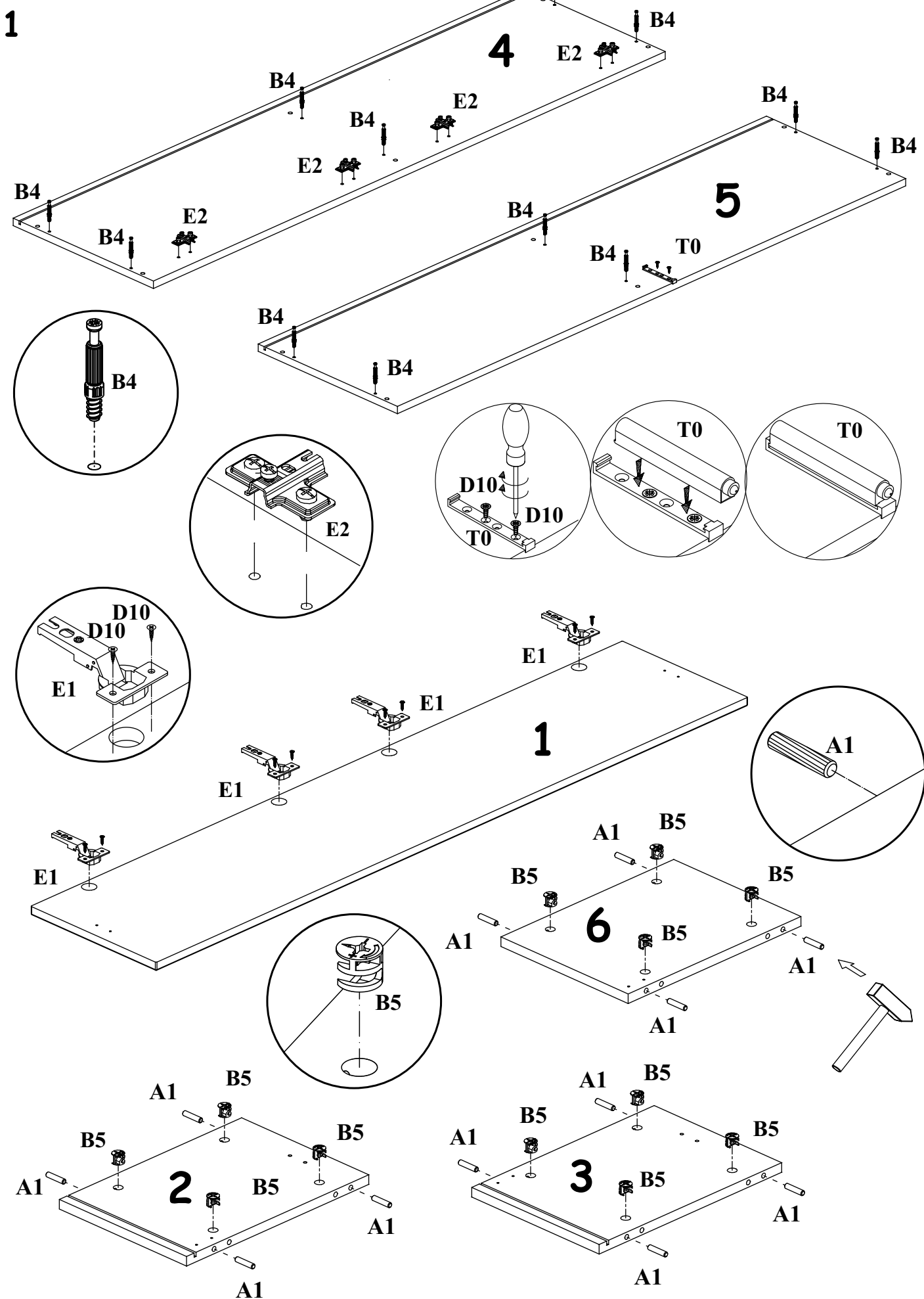

2

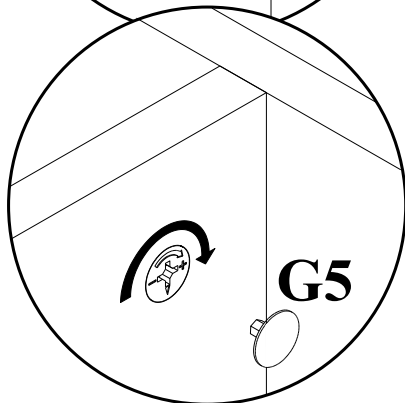
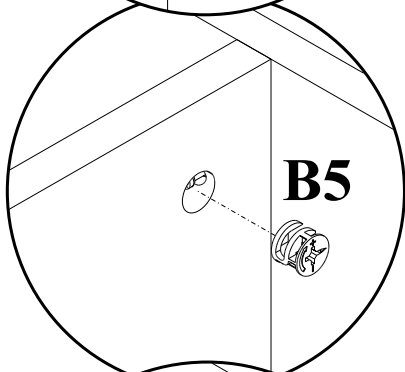
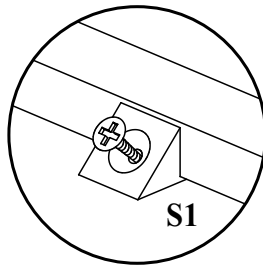
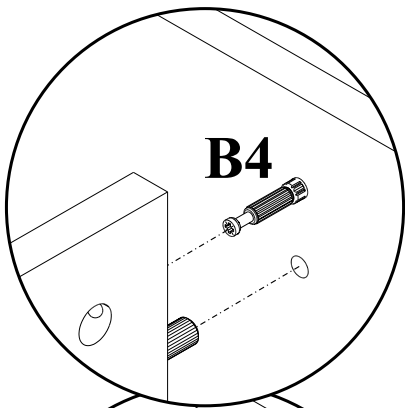
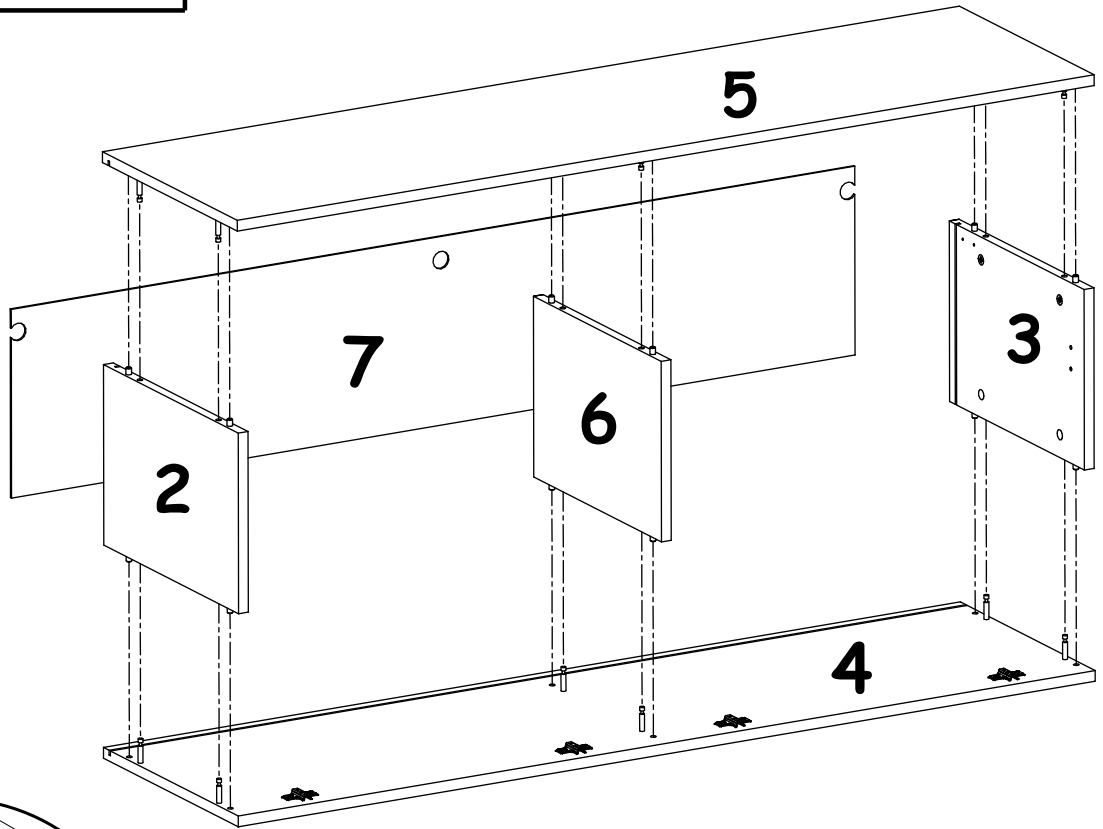

$X=Y$   $90^\circ$

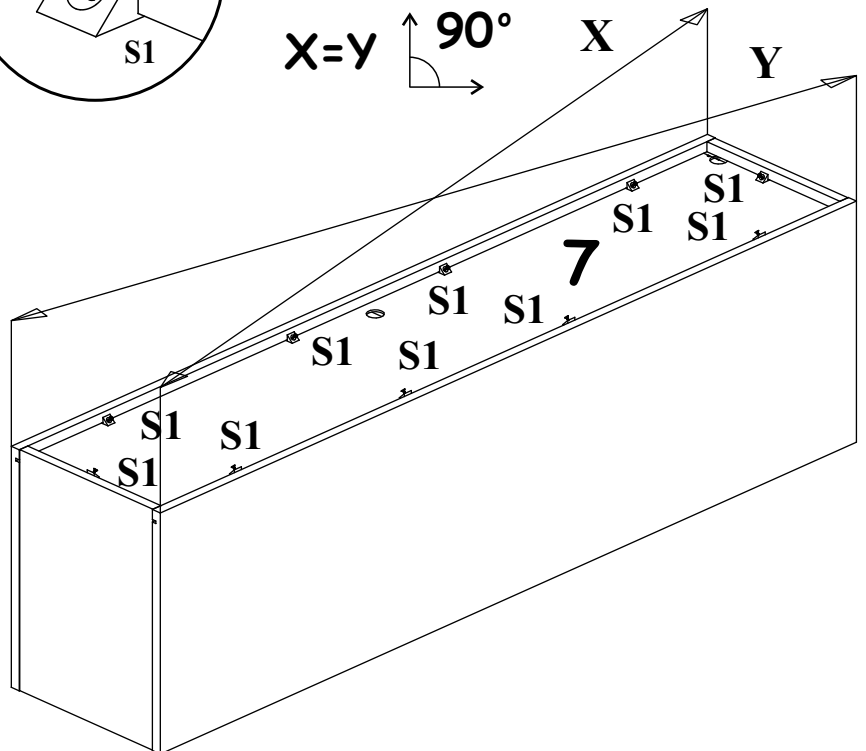

3

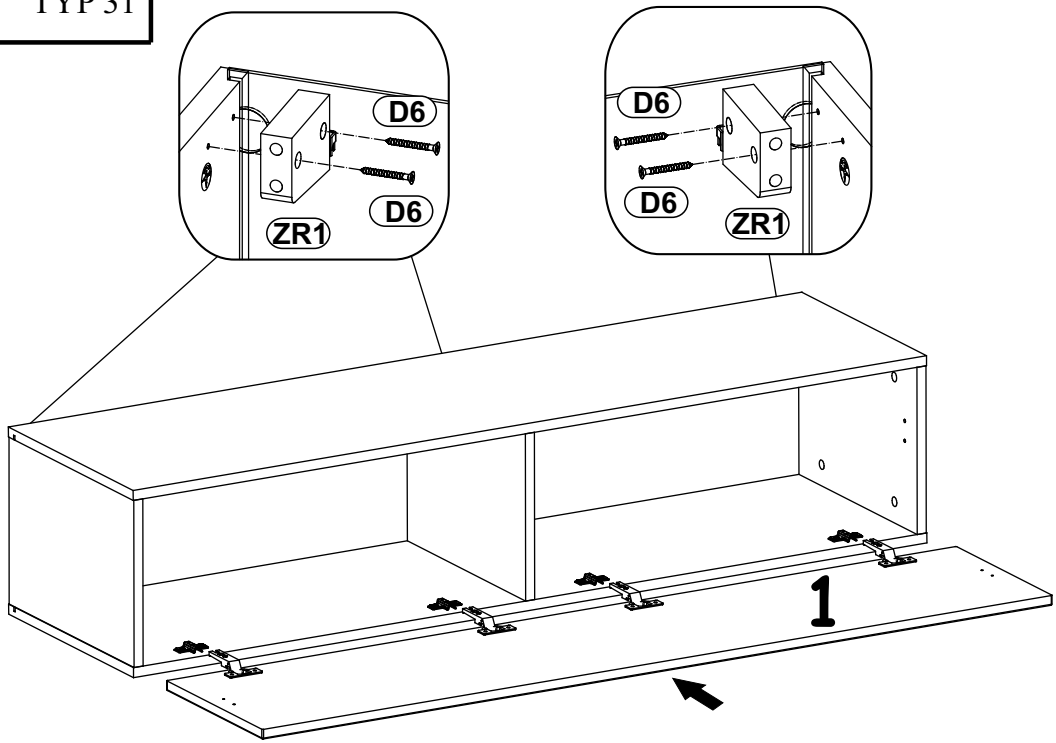

4

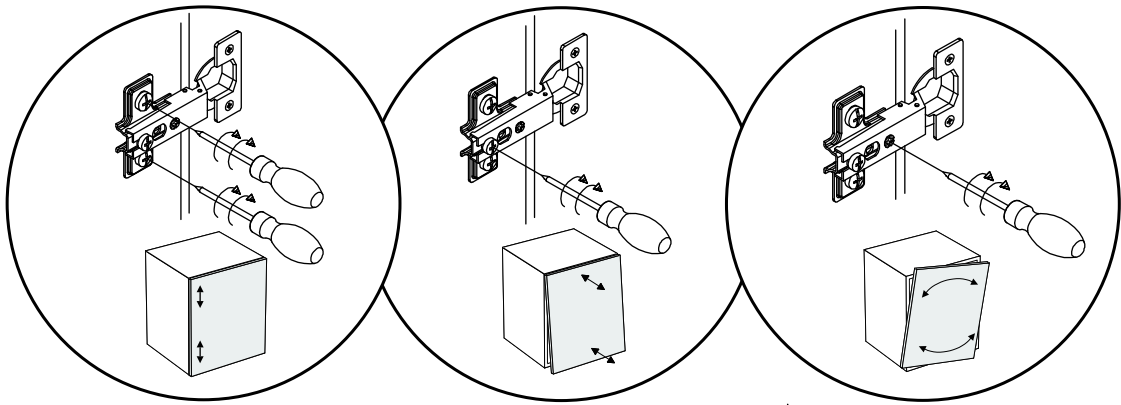
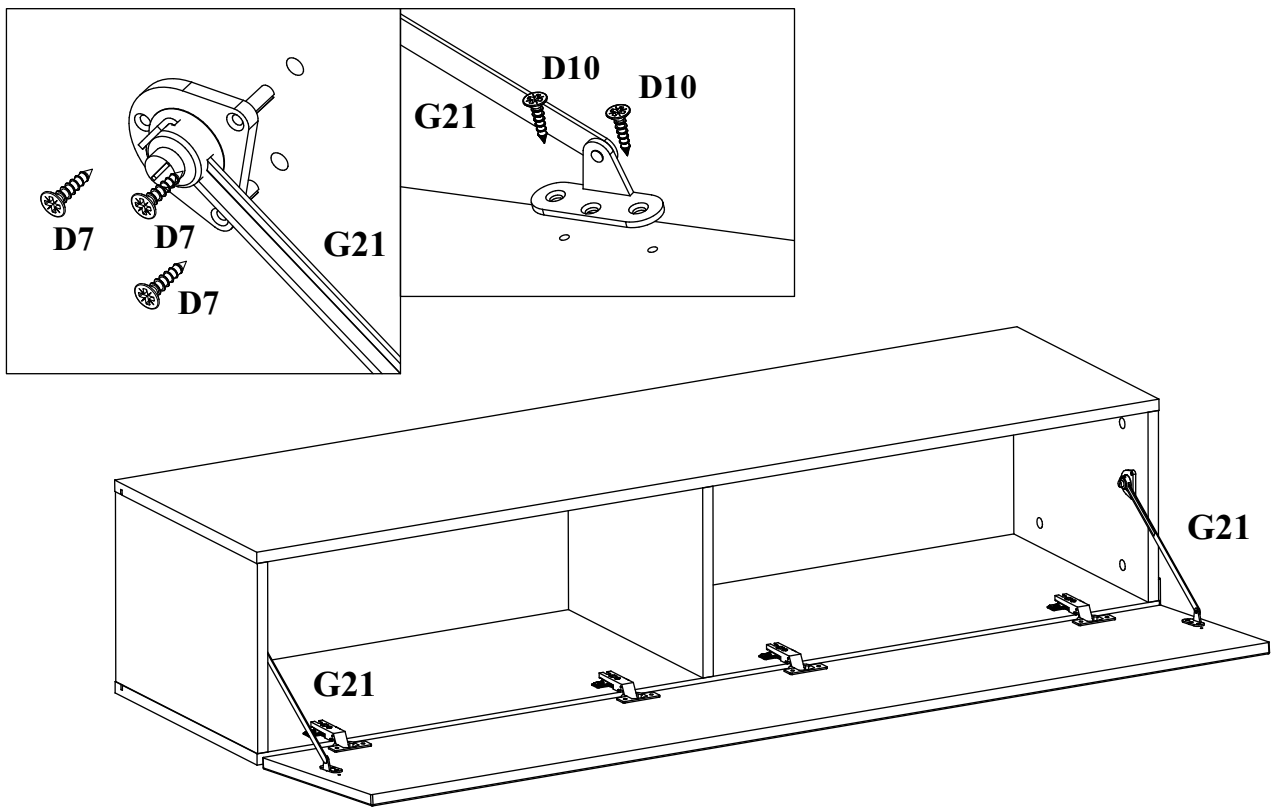

5

