

# INDIANAPOLIS 1-24

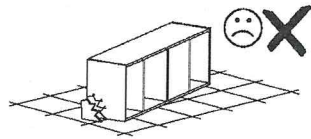

Narzędzia potrzebne do montażu

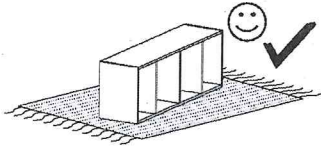
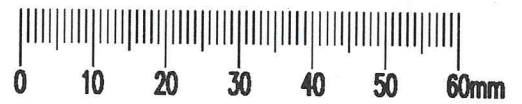
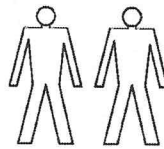
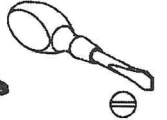
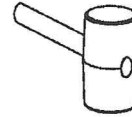
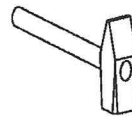

**UWAGA!**  
MONTOWANIE USZKODZONYCH  
ELEMENTÓW POWODUJE UTRATĘ  
GWARANCJI

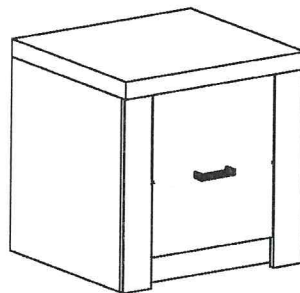

W przypadku reklamacji proszę o podanie numeru pakowacza znajdującego się na kartonie

 C - 2 St.	 D - 2 St.			
	 A - 4 St.	 U - 1 St.	 K - 4 St.	 N - 2 St. M4 x 25 mm
 E - 30 St.	 B - 14 St.	 G - 4 St. 3,5 x 16 mm	 Z - 1 St.	 L - 4 St.

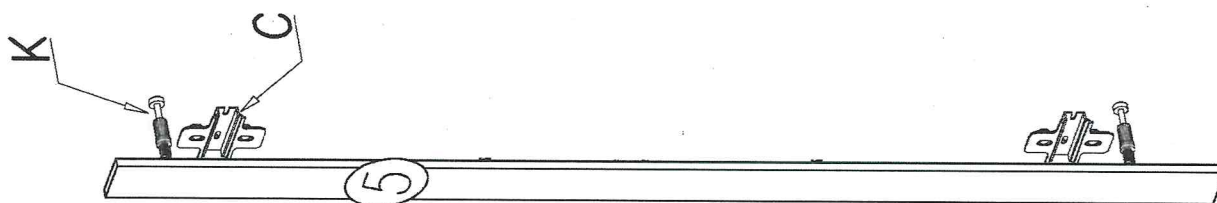
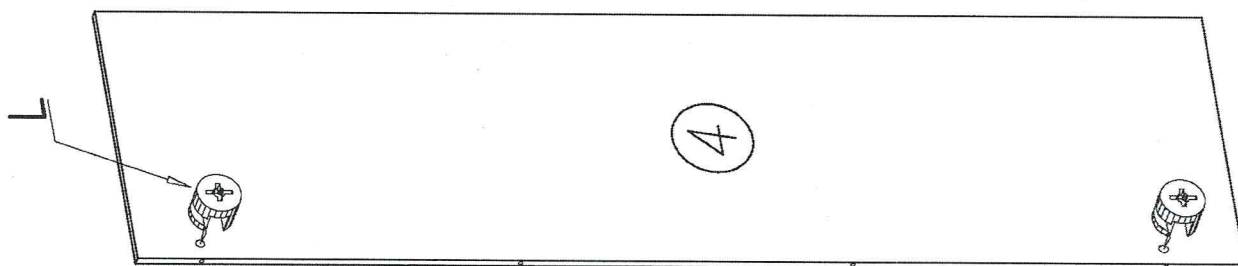
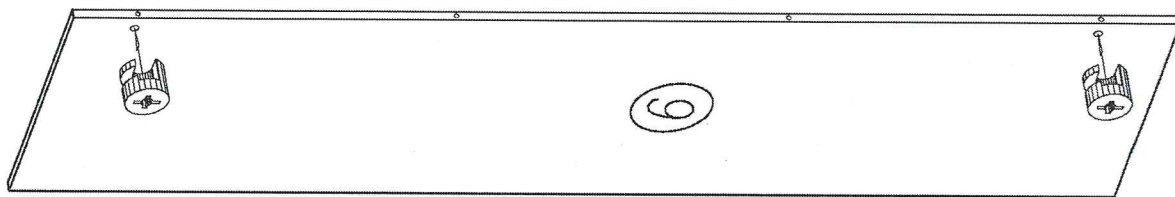
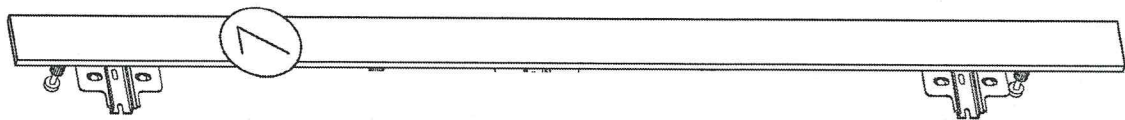

1

II

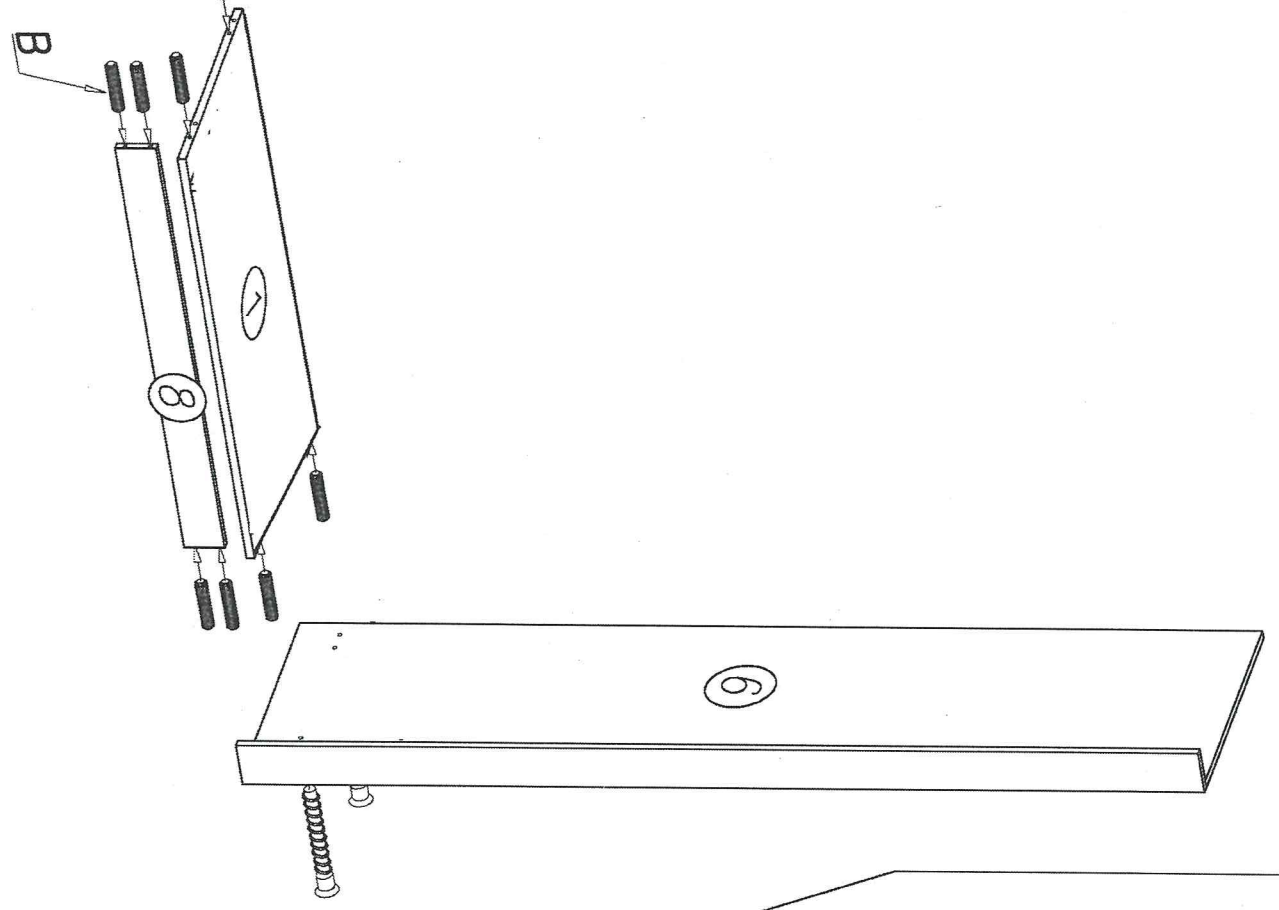
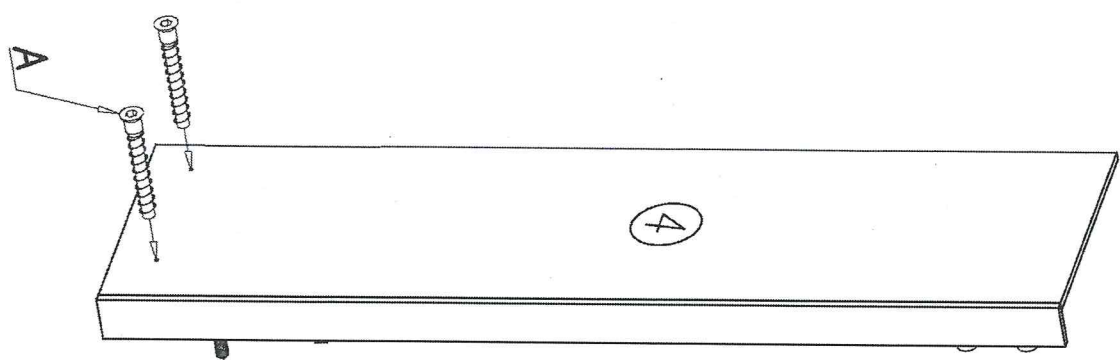

III

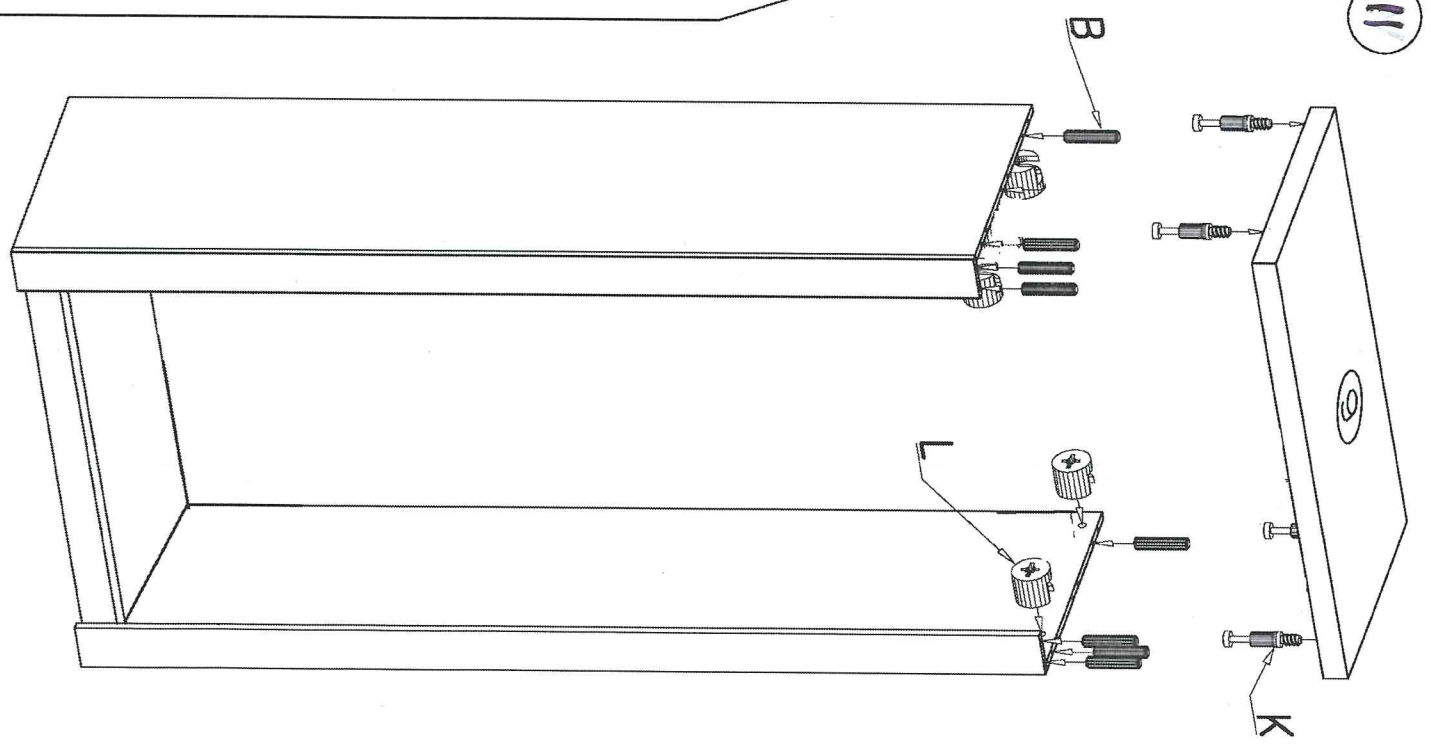

11

