

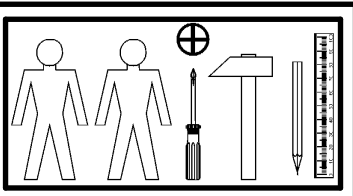

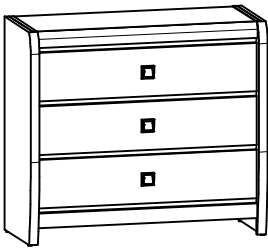

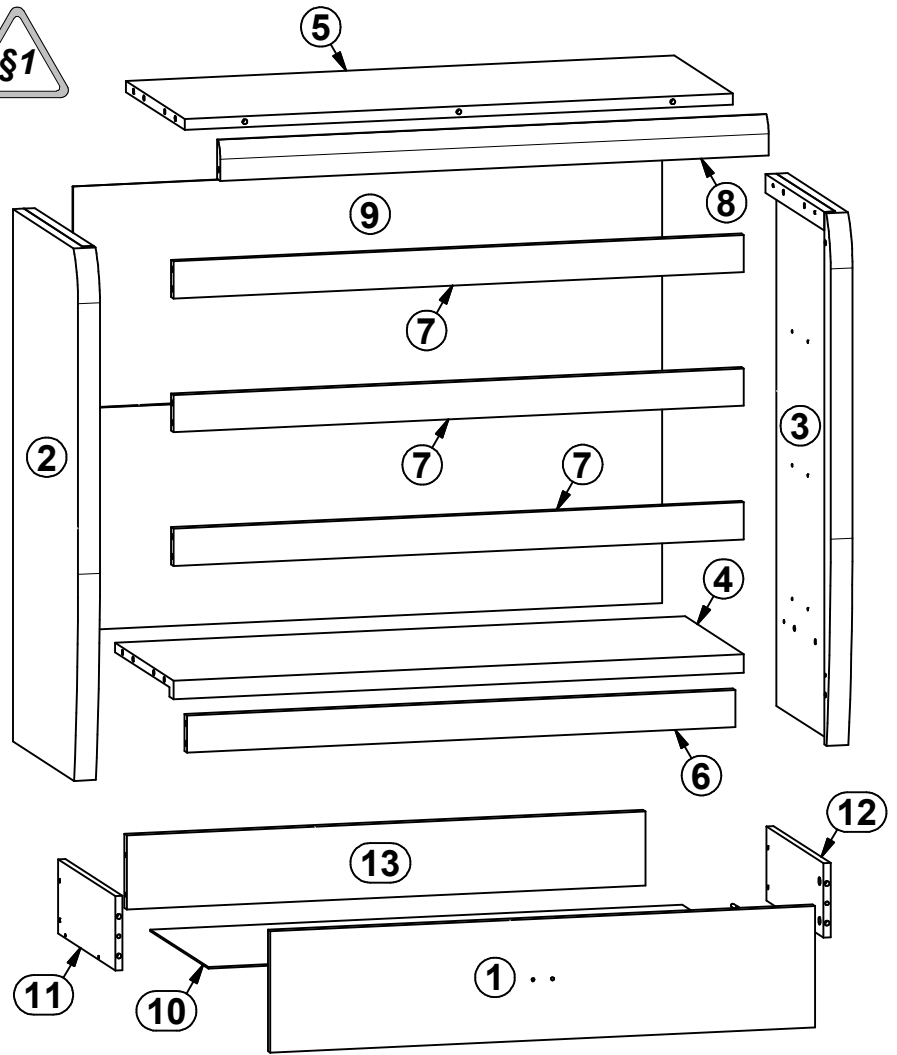



















LOREN

S163-KOM3S

A	B	C	D
1	S163-003	896	196
2	S163-105	860	400
3	S163-106	860	400
4	S163-301	938	359
5	S163-304	902	360
6	S163-404	902	60
7	S163-405	938	60
8	S163-503	902	64
9	S163-903	969	717
10	S163-904	875	355
11	ZS4-501	350	120
12	ZS4-502	350	120
13	ZS3-5512	853	120



3x  c333	18x  Ø6x30 mm e16	12x  Ø5x9 mm e19	24x  Ø8x30 mm f1	6x  Ø6x30 mm f9	12x  Ø6,5x40 mm f25	6x  M4x20 mm j1	4x  k1	40x  l1
3x  Ø3,5x16 mm p25	3x  Ø3,5x10 mm p35	18x  Ø3,5x16 mm p38	13x  Ø15x12 mm #16 r1	12x  Ø12x10,5 mm #12 r15	25x  r16	3x  350 mm t35	18x  H=18 mm w36	3x  350 mm w45\CL
3x  350 mm w45\CR	3x  350 mm w45\DL	3x  350 mm w45\DR	1x  n26\1	1x  Ø3,5x16 mm p38				

1 §2

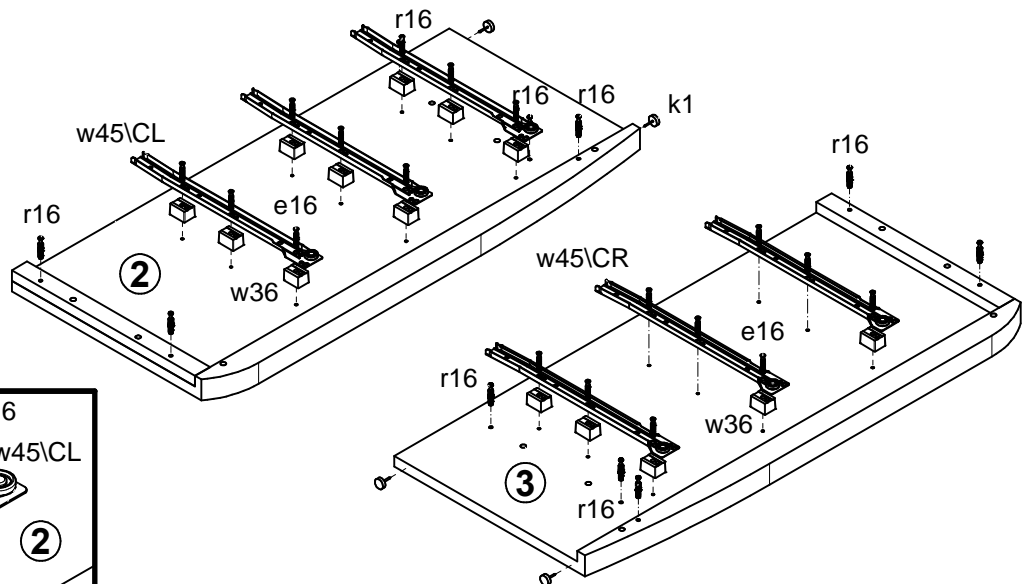
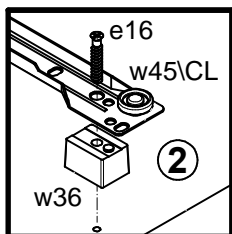
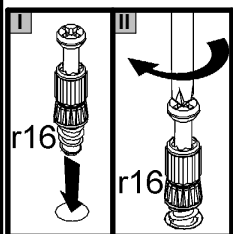
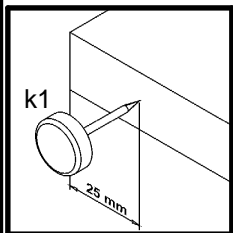

2

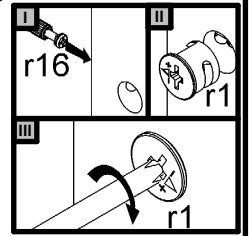
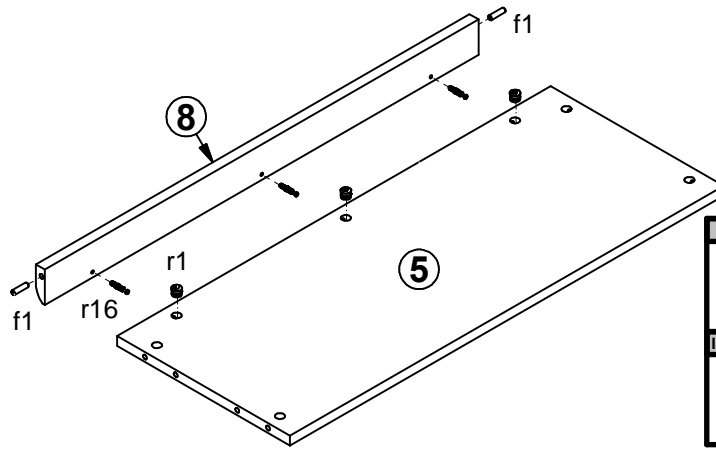
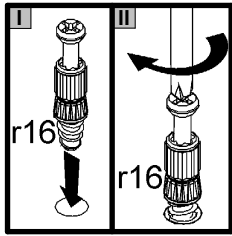
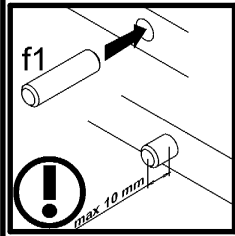

3

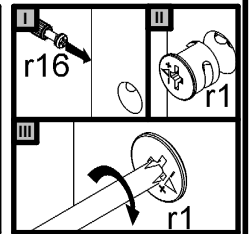
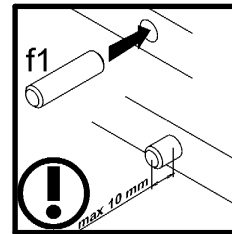
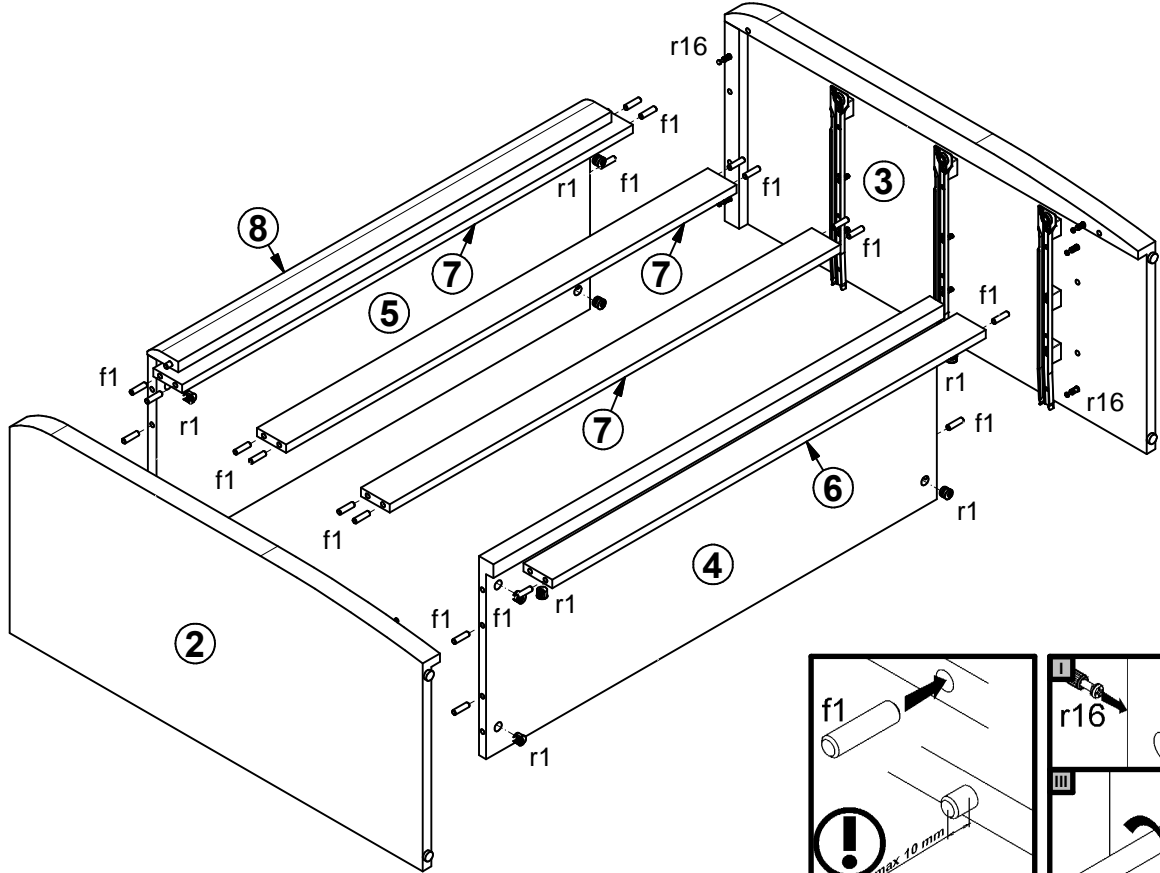

4

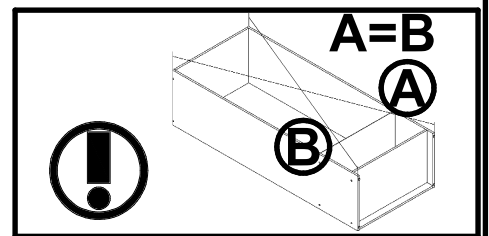
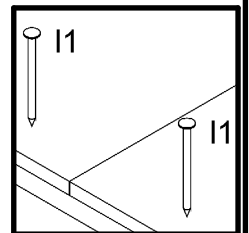
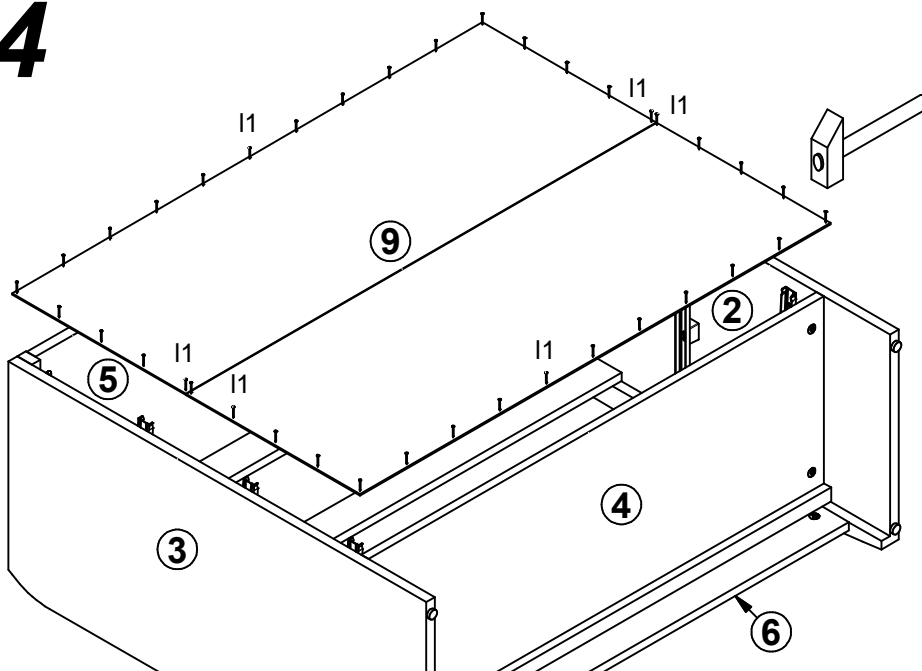

5

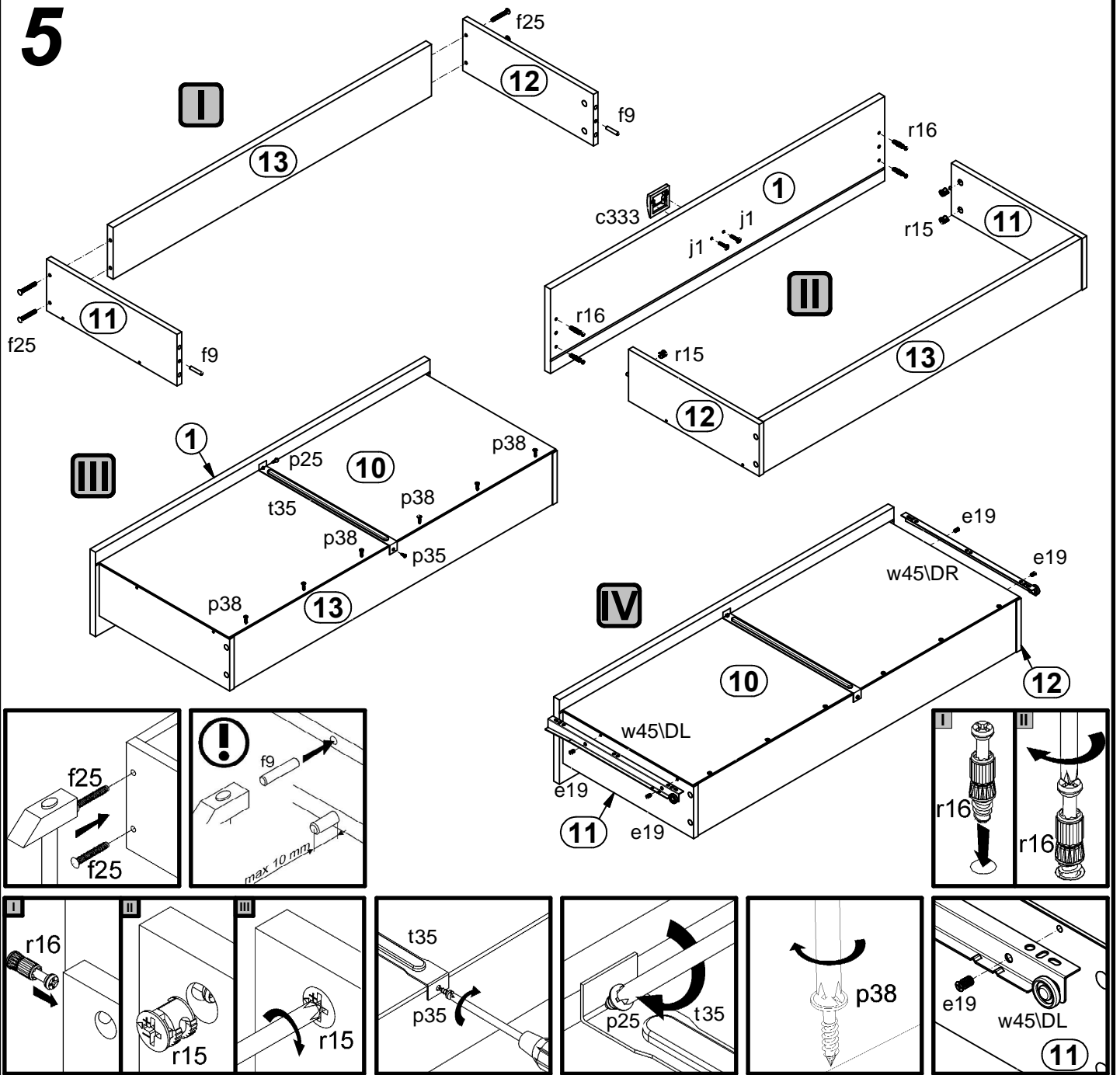

6

