

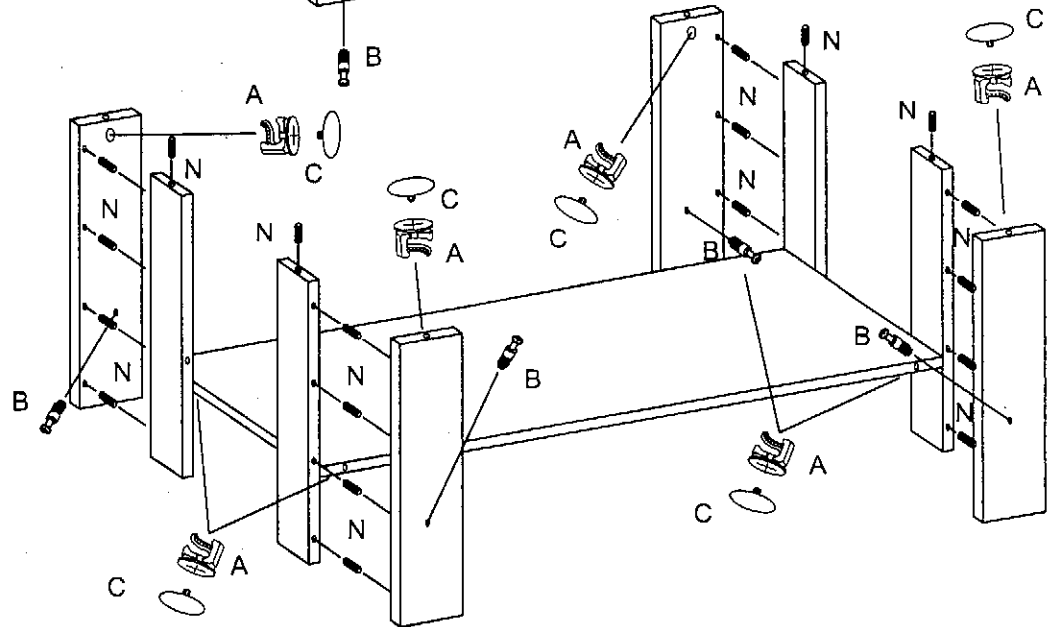

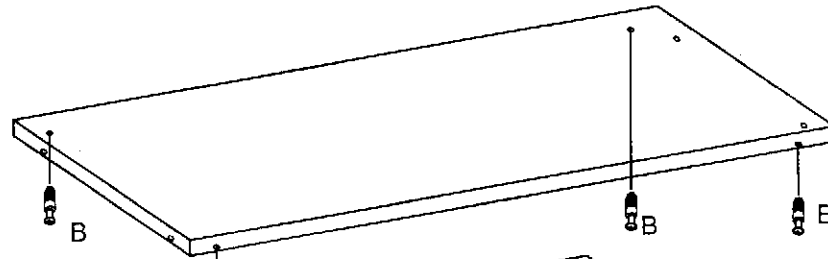

T23

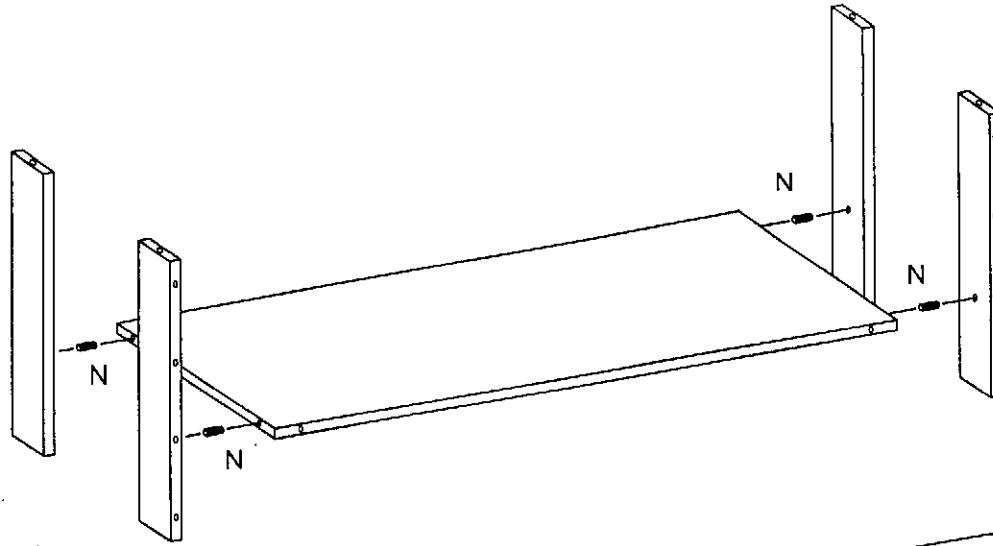
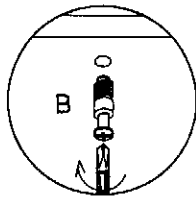
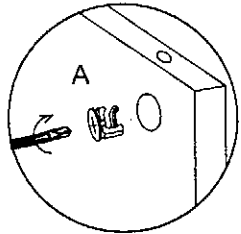
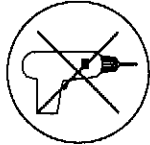
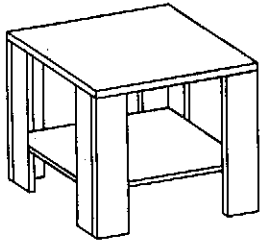
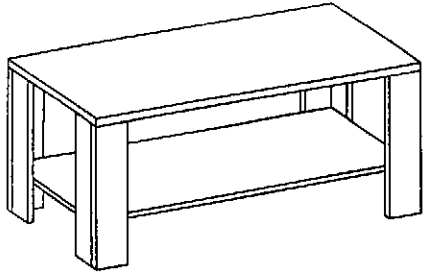

			
8 A	8 B	8 C	24 N